

碩久科技

產品及解決方案

簡報人：JerryPeng | 簡報日期：2022-06-27



產品及解決方案

硬體

- 4G 控制器
- LoRa 控制 轉換 模組 天線
- Pi CM4多功能控制器
- 5G控制器
- Analog Input Modbus Gateway
- Modbus RTU with 4DI / 3DO
- LoRa Digital IO Controller
- SIP Phone
- LoRa模組
- LTE模組 5G 模組
- 各型感測器
- 室內 戶外 天線連結線

軟體

- 控制器客製化軟體開發
- 現場設備至資料庫及網頁呈現專案開發(使用 LTE 建立 PLC 遠距 VPN 網路)
- 4G VPN Gateway
- Modbus Gateway
- DO 告警 Line通知
- 智慧路燈管理平台

應用場域

1. Modbus 資料收集
2. 廠區設備溫溼度監控
3. 電力監控(設備能耗、減碳....)
4. 工業空氣汙染監控
5. 農業應用(水&土壤感測....)
6. 使用 LTE 建立 PLC 遠距 VPN 網路
7. PLC無線監控
8. 太陽能無線監控
9. IP cam無線影像傳輸





主系統架構

Smart City

IoT Solutions

Industry Automation

Applications

Street Light Server

VPN Server

MaxLong API Server

Cloud Services

4G

4G

4G

VPN/4G Gateway

LoRa-to-4G / RTU-to-4G Gateway



4G Lighting

RJ-45

LoRa

RS-232/RS-485

RS-485



IP CAM



LoRa Smart Plug



Power Meter + LoRa Converter



PLC



Power Meter



Thermometer/CO2

跨棟逆變器資料收集

- 處理問題：逆變器跨棟資料收集
- 解決方案：透過LoRa無線傳輸
- 方法：
 1. 跨棟多個逆變器，透過LoRa傳輸至4G控制器，回傳雲端
 2. 解決太陽能逆變器在不同棟之間的資料收集
 3. 省去施工拉線，及每棟4G SIM卡及控制器費用



LoRa+4G控制器



LoRa 傳輸器 RS485

各廠牌逆變器

使用 LTE 建立 PLC 遠距 VPN 網路

- 處理問題：既有系統面對PLC通訊無法佈線問題
- 解決方案：4G LTE 控制器透過雲端進行資料交換 (可包含SIM卡)
- 方法：
 1. 設備設定VPN連線至碩久雲端Server
 2. 雲端 Server 協助交換封包，讓 PLC 與 PLC 之間形成區域網路，直接對連與傳統 VPN 架構，支援 Layer 2 相同
 3. 解決遠距離無法施工佈線問題

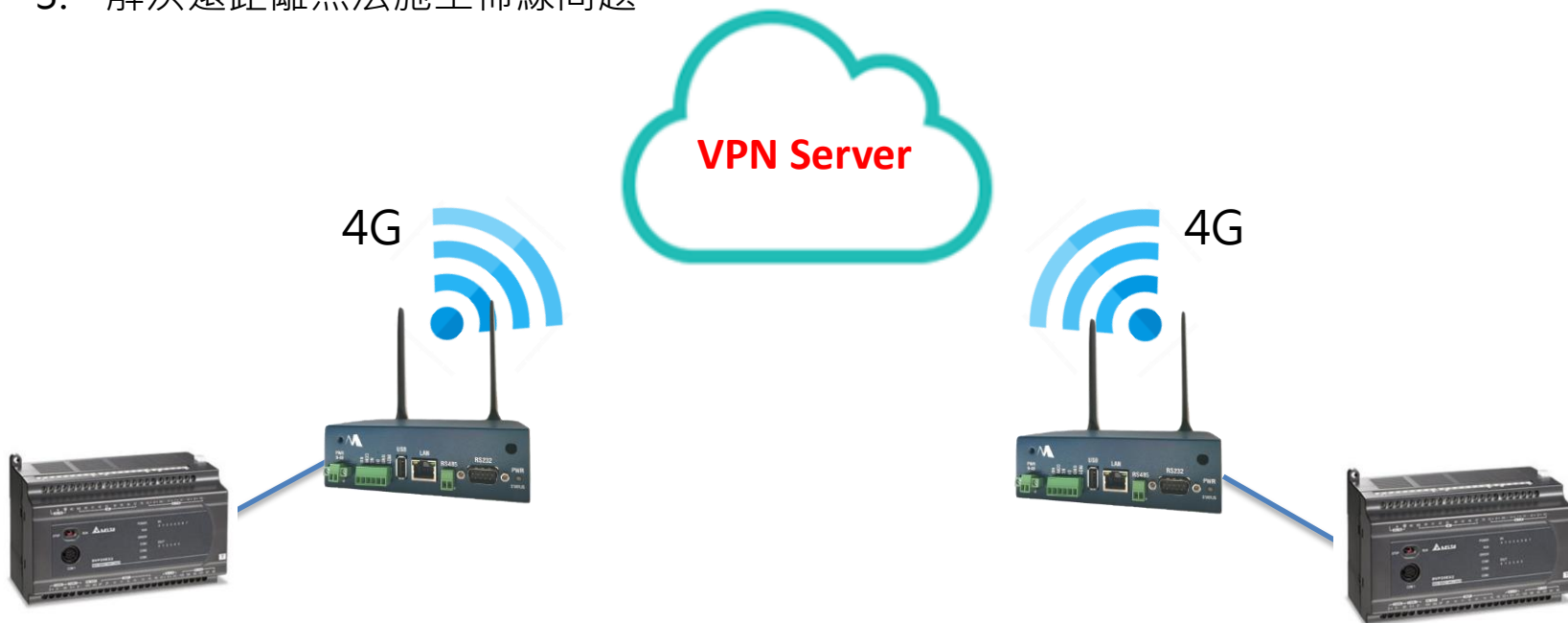

Line告警系統

LINEBOX 即時事件通知服務

碩久科技有限公司
MaxLong Technology Co., Ltd
www.maxlong.com.tw

產品特性

“生產現場走不開”，不再是您所顧慮的因素，讓員工輕鬆老闆安心新利器

■ **處理問題**：廠區設備DO 輸出，如：電力契約
過載、水位異常、設備警報、機房警報。

■ **解決方案**：碩久Line Box控制器（可包含SIM卡）。

■ **方法**：

1. 控制器透過4G或有線網路上網進行line告警。
2. 現場只需電源與DO點。
3. 警報發生即時line通知，每日定期回報。
4. 解決現場警報及狀態無法掌控。

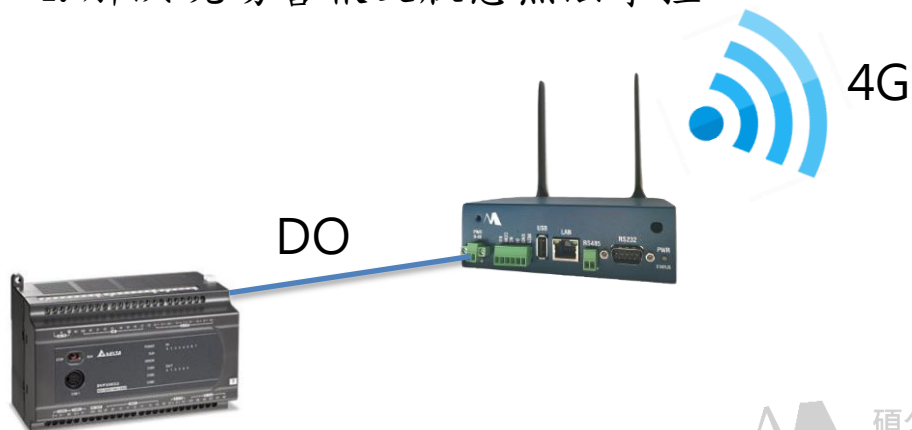

Line box 能耗監控解決方案架構



Line box 能耗監控解決方案現場實績

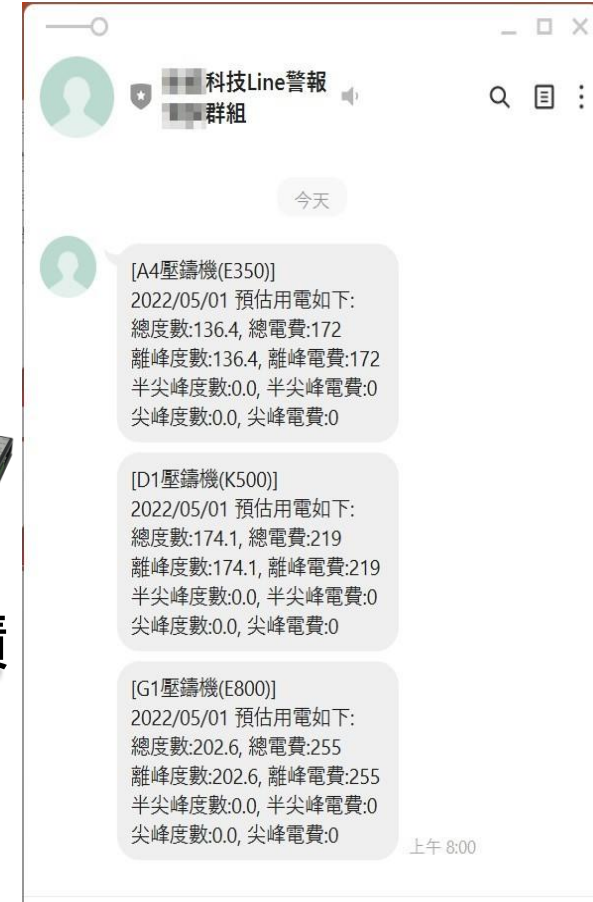
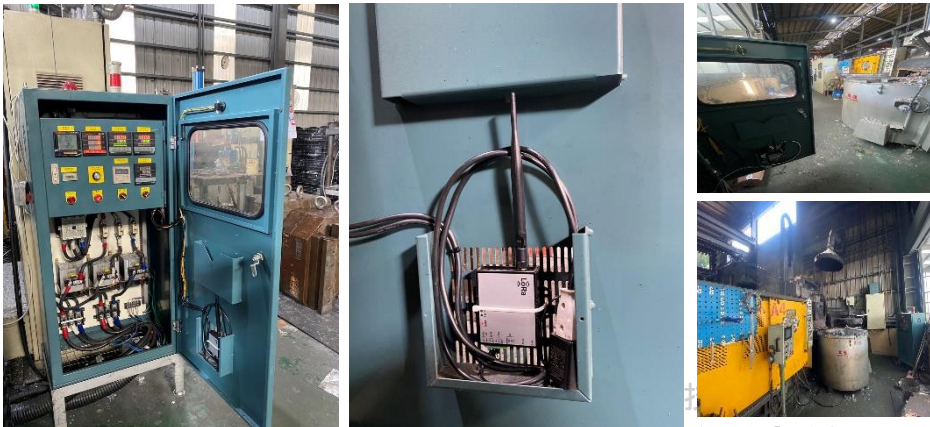

<https://youtu.be/g1UScoCwKs> 現場連結影片

廠區溫溼度收集

- 處理問題：系統安裝商，對於散佈與廠區環境資訊收集需求
- 解決方案：透過LoRa無線傳輸
- 方法：
 1. 廠區各位置多個感測器，透過LoRa傳輸至控制器，回傳伺服器
 2. 解決廠區內，感測元件資料收集無法佈線及彈性建置需求
 3. 省去施工拉線時間及費用，快速安裝



LoRa+4G控制器



LoRa 傳輸器 RS485



各廠牌逆變器

廠區能源監控機台耗電資訊收集

- 處理問題：工廠機台能源消耗與稼動率資料收集
- 解決方案：數位電表透過LoRa無線傳輸
- 方法：
 1. 多個機台建置數位電表，透過LoRa傳輸至LoRa控制器，回傳資料庫
 2. 解決現場建置通訊線路費用及難度

地球暖化

減碳



LoRa+4G控制器

LoRa™

LoRa™



LoRa 傳輸器 RS485



各廠牌電表



紡織業機台資料收集

- 處理問題：系統整合商無法拉線機台資料收集
- 解決方案：透過LoRa無線傳輸
- 方法：
 1. 紡織機台透過LoRa傳輸至LoRa控制器，回傳雲端
 2. 解決現場機台無法建置實體線路資料收集



LoRa+4G控制器

LoRa™

LoRa™



LoRa 傳輸器 RS485



紡織機

電子廠空污系統跨廠區監控

- 處理問題：跨廠區跨棟頂樓空屋系統料收集與監控
- 解決方案：PLC透過LoRa無線傳輸
- 方法：
 1. 空汙塔PLC透過LoRa傳輸至LoRa控制器回傳監控系統
 2. 解決現場建置通訊線路費用及難度

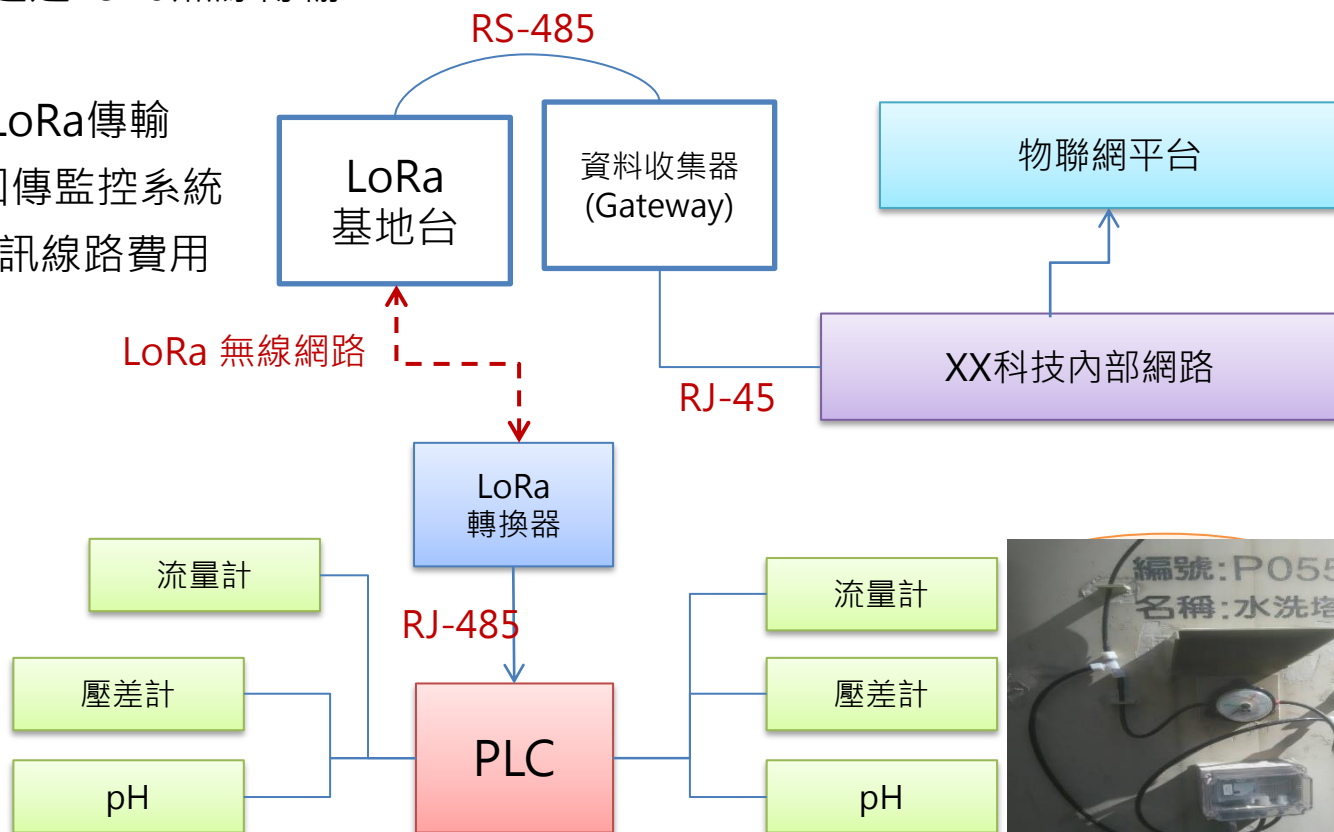

LoRa 農業應用架構



- 處理問題：田間感測器資料收集
解決方案：LoRa無線傳輸
- 方法：
 1. 田間透過LoRa傳輸至LoRa控制器回傳資料庫
 2. 解決現場建置通訊線路費用及難度

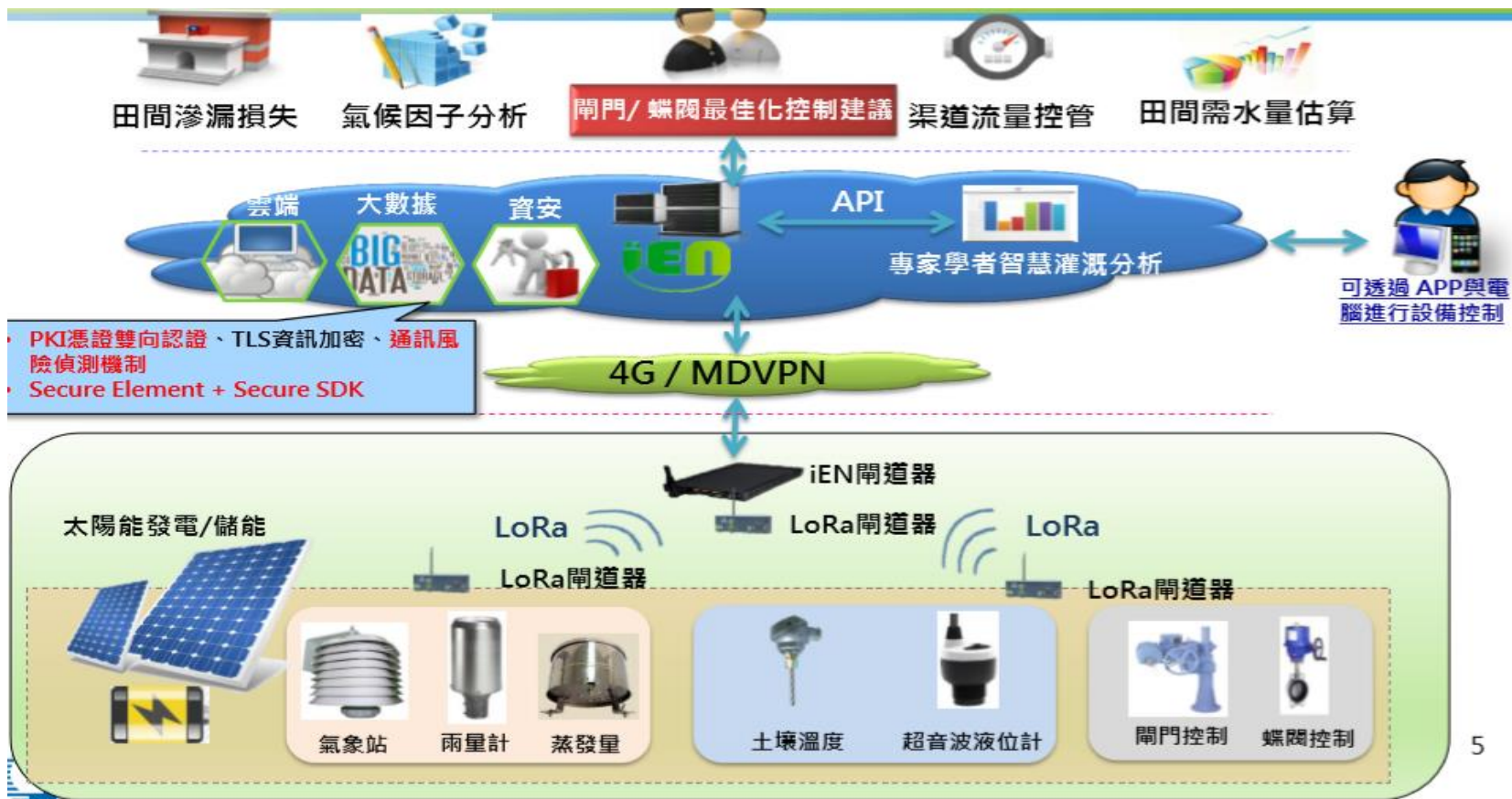

智慧路燈系統架構

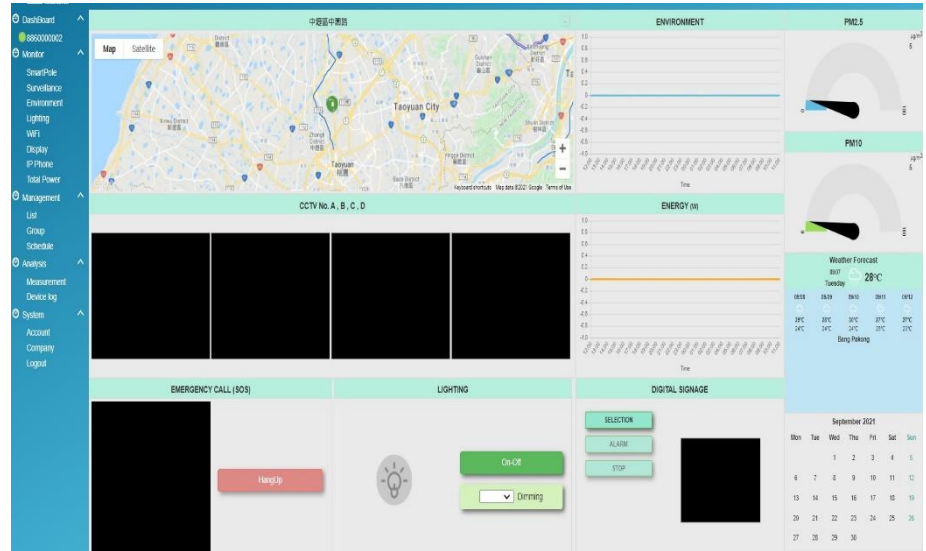

NEMA socket



SIP Phone



溫溼度 PM2.5 sensor



LoRa轉換器



沉水式水位計Sensor

智慧路燈整合清單

1. 系統網頁呈現
2. 資料收集
3. 控制器
4. LoRa NEMA Scoket路燈控制器
5. 各式sensor 整合

複製到
其他應用

1. 能源管理
2. 設備稼動率
3. 控制器
4. LoRa NEMA Scoket路燈控制器
5. 各式sensor 整合



登入畫面



首頁資訊

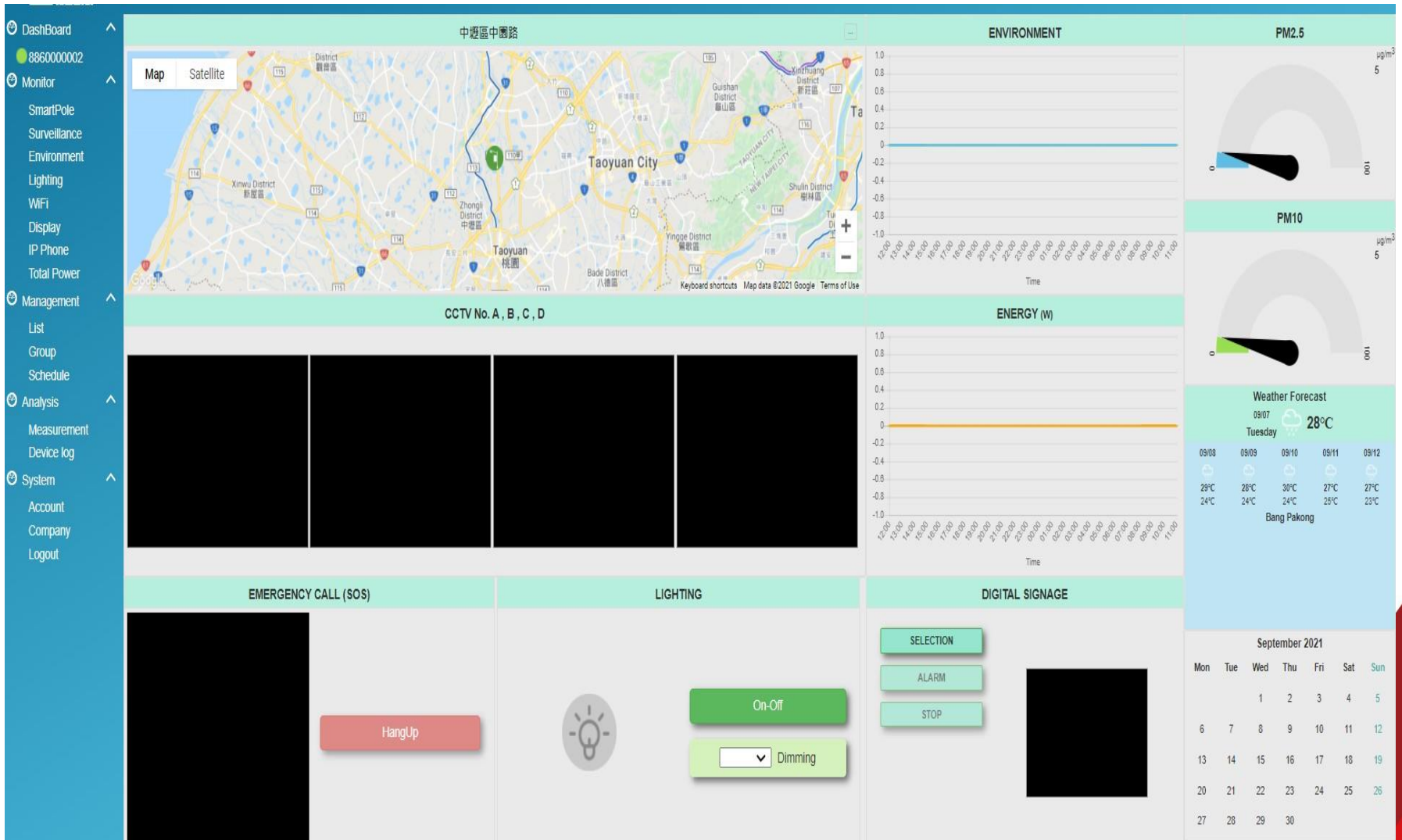

各類清單及設定

Dashboard 886000002

Monitor

- SmartPole
- Surveillance
- Environment
- Lighting
- WiFi
- Display
- IP Phone
- Total Power

Management

- List
- Group
- Schedule

Analysis

- Measurement
- Device log

System

- Account
- Company
- Logout

#	Name	Remark	Enable	Update time	Update account
5	<input type="text" value="Delta"/>	<input type="text" value="12345"/>	No <input type="button" value="Save"/>	2021-09-02 14:16:39	admin
New	<input type="text"/>	<input type="text"/>	Yes <input type="button" value="Save"/>		



單點資訊系統

Map Satellite

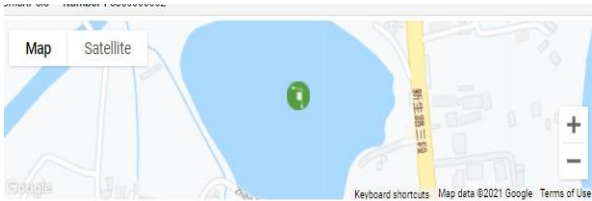

Longitude 121.220000 Latitude 24.990000

Address 中環區中環路

P Phone Number : 1

SIP Number sip:ep0110004@172.104.70.209

Status Disconnect

P Speaker

No device.

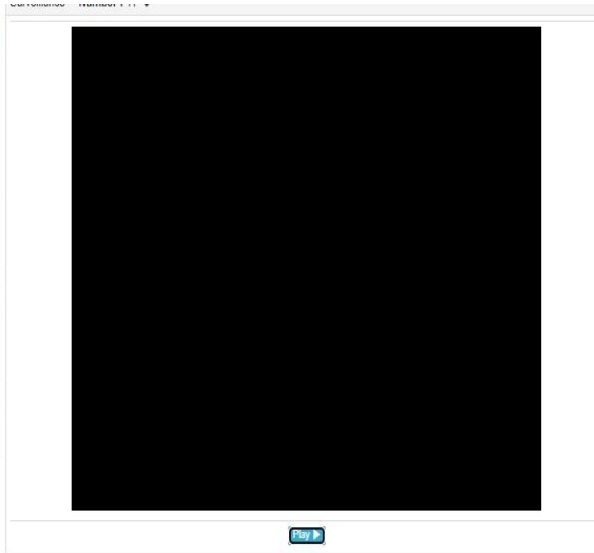

No device.

WiFi

No device.

Display Number : 1



Snapshot Time [Refresh](#)

Play List -No Play List - [Play](#)

Status Disconnect

Total Power Number : 31

Report 2021-09-06 12:07:00	Status Disconnect
Voltage 121.03 V	Current 0.0 A
Power 0.0 W	

Lighting Number : 11

Report 2021-09-06 12:06:59	Status Disconnect
Power 54.0 W	Voltage 120.0 V
Current 0.447 A	PF 0.996
RSSI 0.0 dBm	Switch Closed
Dimming 100 % <input type="button" value="Off"/> <input type="button" value="Submit"/>	<input type="button" value="Submit"/>

Environment Number : 1

Report 2021-09-06 12:07:00	Status Disconnect
Temperature 25.46	PM2.5 5.0
Moisture 55.97	PM10 5.0

[Refresh](#)

增修找查

Dashboard ^

886000002

Monitor ^

- SmartPole
- Surveillance
- Environment
- Lighting
- WiFi
- Display
- IP Phone
- Total Power

Management ^

- List
- Group
- Schedule

Analysis ^

- Measurement
- Device log

System ^

- Account
- Company
- Logout

Type	Group	Pole	Number	MAC	Status	Order By			
- All -	- All -						Search	Add	Delete



Modbus TCP to Modbus 系統架構

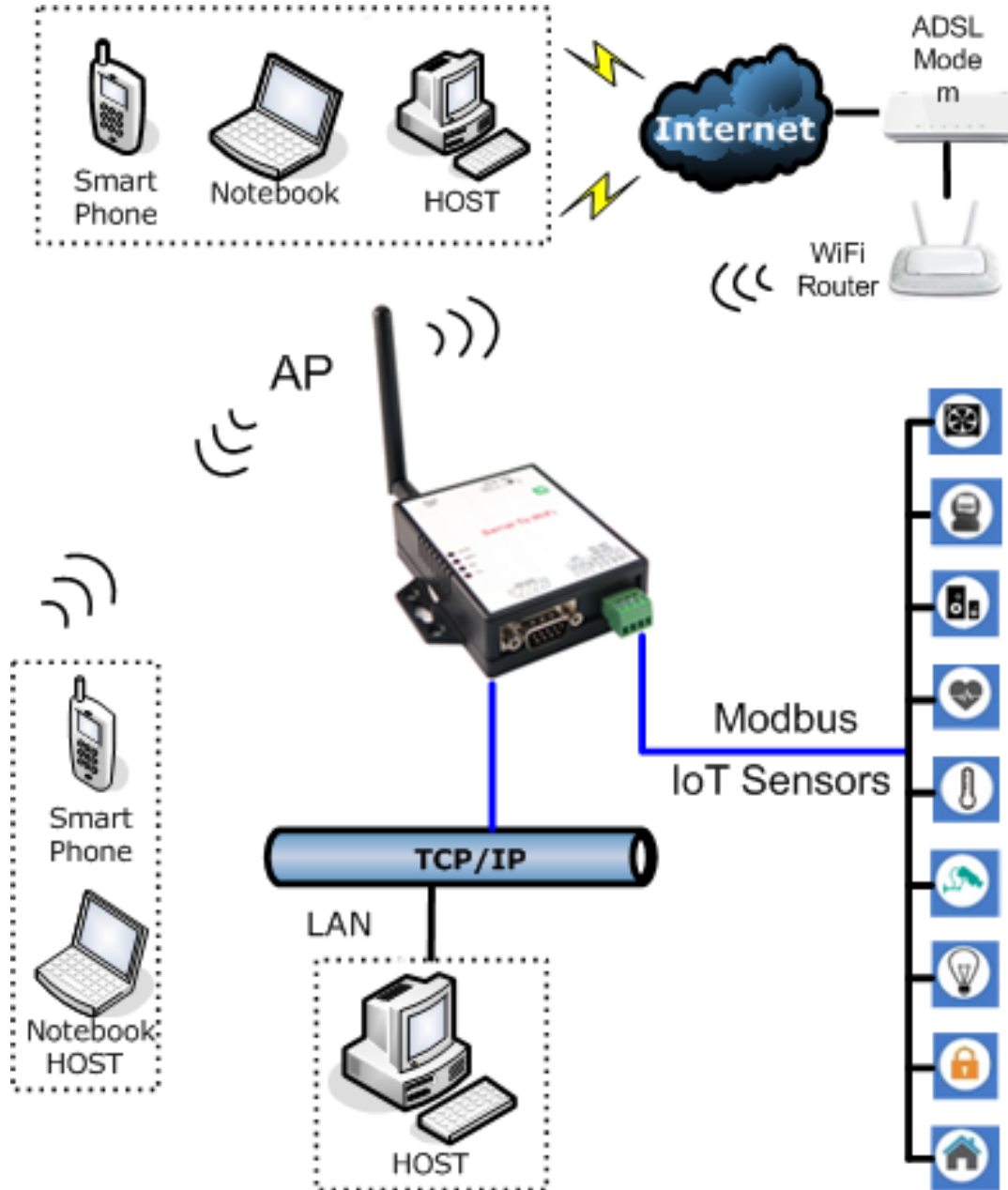



案場實績

紡織業LoRa應用



碩

台電LoRa基站



說明：LoRa 基站安裝 ↻



說明：LoRa 基站安裝完成 ↻



說明：LoRa 基站電源開關 ↻



台電LoRa TCG案場實績



說明：#1 ATRR 相 TCG 電源線配置



說明：#1 ATRR 相 TCG 電源線、訊號線配置



說明：#1 ATRR 相 LoRa 配置

即時擷
取資料
省去人
工抄表



說明：#1 ATRR 相 TCG 安裝完成

Line Box 告警實績

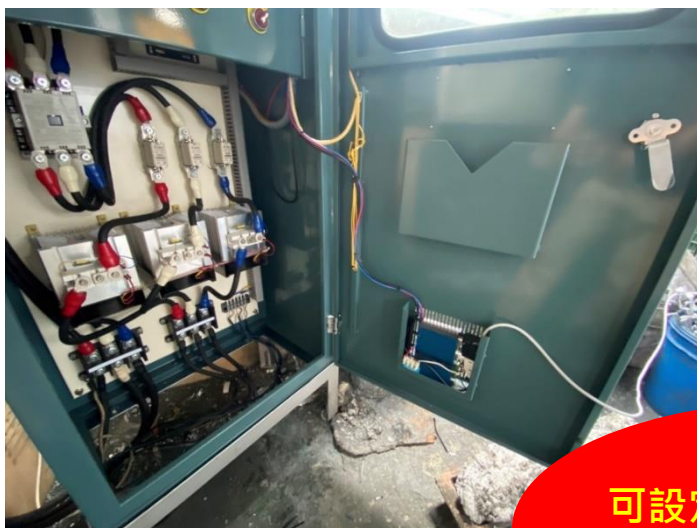

高危險環境
可設定Line定時回報，
即時告警，減少災害
的發生



電子廠空污系統LoRa

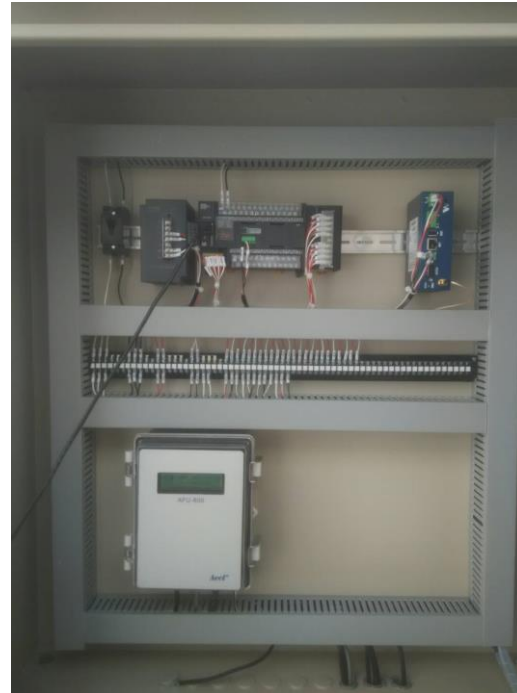

LoRa農業應用照片

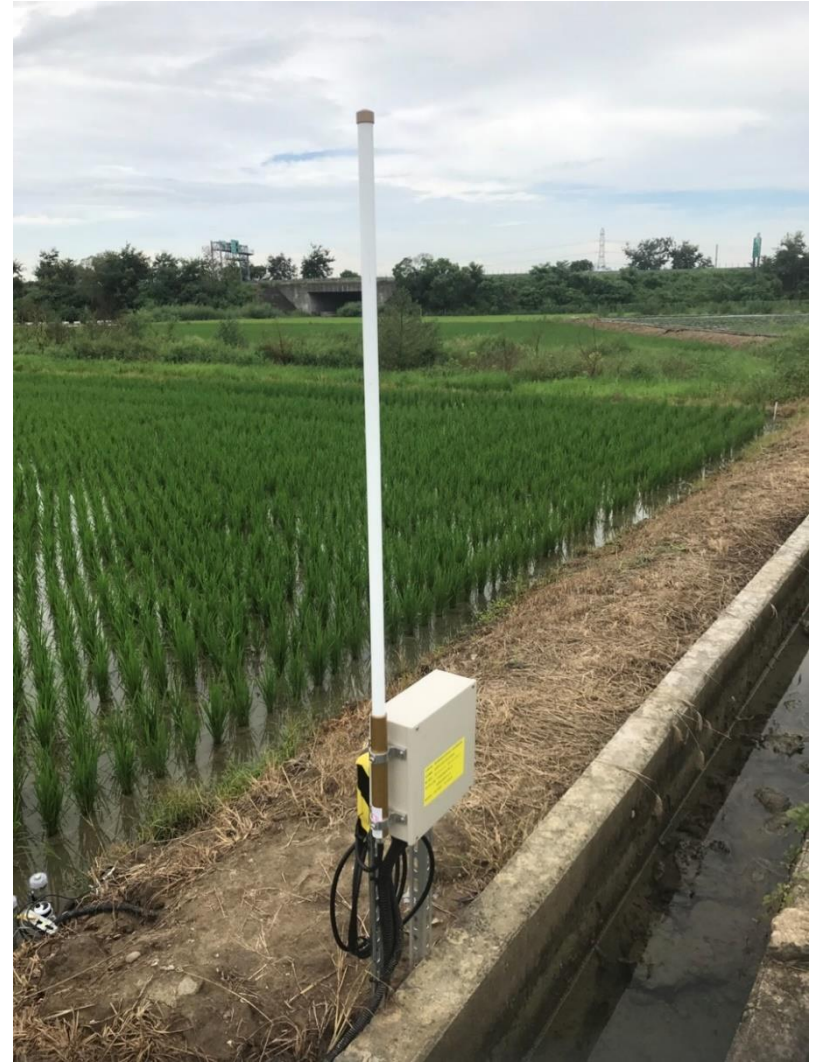

LoRa太陽能發電監控



LoRa技術特性

技術特性	說明
通訊技術	LoRa 862~932 MHz 透通模式或 Modbus (非 LoRa WAN 協定)
傳輸模式	多端點依頻段構成廣播網路 一次只能一個端點發出訊號 (類似傳統對講機設計) 僅適合 1 Master + n Slaves 的應用
通訊流量	每個封包最大承載 255 bytes 資料 每秒最多發送 5 個封包(視封包大小而定)
Gateway轉換介面	Ethernet ,RS-232 , RS-485, 4G(選配)
Converter 轉換介面	RS-232 與 RS-485
實測通訊距離	高度100cm實測兩端點 2 公里



碩久LoRa控制器優勢

1. 控制器提供SDK開發工具，可以針對需要收集的設備進行軟體修改
2. 設定簡單
3. 提供RS232 / RS485 / Etherne或4G LTE彈性使用
4. 廣播方式不需要配對，施工維運簡易
5. 即時回傳(不需等待50-150秒)
6. 可以先將資料收集儲存整理後再回傳
7. 室內用戶外用機種齊全
8. 提供完整室內外天線



碩久LoRa轉換器優勢

1. 隨插即用
2. 設定簡單
3. 提供RS232 ,RS485,彈性使用
4. 廣播方式不需要配對,施工維運簡易
5. 即時回傳(不需等待50-150秒)
6. 室內用戶外用機種齊全
7. 提供完整室內外天線
8. 無線配對與更改參數





產品介紹

SLG1211A



- > SDK platform provides User development bonus
- > Com Port is convenient to use
(RS232 uses DB9 standard interface, RS485 uses TB interface)
- > Built-in Micro SD card Storage can record and store data
- > The same platform product portfolio is flexible
(3G/4G/Modbus/GPS/TCP TO RTU/VPN)
- > Remote software update software through the network
- > Special treatment can be dustproof and waterproof



- Industrial grade hardware design for harsh environment
- Support Message Queue technology(MQTT), connected with cloud and mobile devices
- Designed for machine to machine communication taking advantage 3G/4G and WAN port for internet access
- Provide a variety of serial interfaces and GPIO feature
- Controller support wide voltage input
- When power failure, the Li-ion battery can ensure controller alive
- Built SD port to sure the data save when wireless is disconnect

SKY LoRa Gateway SLG1211A Specifications

Main Chip
LoRa Transmission : Semtech SX1272
Soc : 1 GHz Sitara ARM Cortex®-A8
Memory: -DDR3 512M Bytes
 -NAND Flash 256M Bytes

Operating System: GNU Linux

LoRa
Frequency: 862~932MHz
Frequency Accuracy: ± 10KHz
Modulation: LoRa
Transmit Power: 2~+20dBm
Data Rate: 0.244~18.2Kbps(LoRa)
High Sensitivity: down to -137dBm
Communication Distance: 2Kkm
Antenna Impedance: 50ohm

USB Port
 1 Port USB Host

Serial Port
RS232/RS485:
 -1 port RS232 with DB9
 (Full Duplex of RS232 /Baud Rate up to 115K bps)
 -1 port RS485 with TB5
 (Half Duplex of RS485/Baud Rate to 115K bps)

Network
Ethernet: 1*10/100/1000 Base-TX LAN port
Protocol: TCP, UDP, HTTP, SNTP, DHCP, FTP, PPP, IPv4

DI/DO
 125 Vac @0.5A, 24 Vdc @1A
Output: 1*Relay Dry Contacts, Terminal Block
Input: 1*Dry Contacts, Terminal Block

Configurations and Management
WEB: Support HTML web control interface
CGI: Support CGI control interface

Firmware: Lan port Support system firmware upgrade

Power Source
Supply Voltage: +9~48 VDC, Terminal Block
Power Consumption@12V: Max 12W

Environment
Operating Temperature: -10°C~70°C

Mechanism
Dimensions: W*H*D: 43*135*96 (mm)
Weight: 450 ± 5g

Option
3G: -HSPA data rate (Mbps)=3.6(DL)
 -UMTS data rate (Kbps)=384(DL)/384(UL)
 -LTE-FDD Max 10M (DL)/ Max 5M (UL)
4G: -HSPA data rate (Mbps)=14.4(DL)/5.76(UL)
 -UMTS data rate (Kbps)=384(DL)/384(UL)
 -LTD-FDD Max 150Mbps (DL) Max 50Mbps (UL)
 -LTE-TDD Max 130Mbps (DL) Max35Mbps (UL)

Battery Supply: Li-ion 1400mAh

LoRa Servers

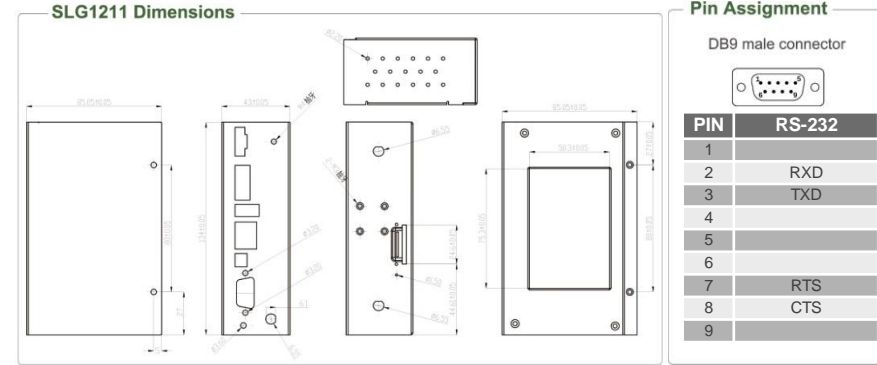

Ordering Information

Model	Description
SLG1211A	LoRa Gateway
SLG1211A-4G	LoRa 4G Gateway
SLG1211A-4G-Modbus	LoRa 4G Gateway Modbus RTU to TCP

Options of Bands/Frequencies (MHz)

Option	4G	
	FDD LTE	TDD LTE
E	B1(2100),B3(1800), B5(850),B7(2600), B8(900),B20(800)	B38(2600), B40(2300), B41(2500)
A	B2(1900),B4(1700), B12(700)	
AU	B1(2100),B2(1900), B3(1800),B4(1700), B5(850),B7(2600), B8(900),B28(700)	B40(2300)
J	B1(2100),B3(1800), B8(900),B18(850), B19(850),B26(850)	B41(2500)

SLC-NEMA01

NEMA控制器



Electrical Parameter Monitor : Vrms(V)、Irms(I)、Power Factor(PF)、Power(W) 、RSSI(dBm)
Light Control : On、Off、Dimming(0-10Vdc)
LoRa Transmission : Semtech SX1272
LoRa Frequency : Frequency Band: 902~928MHz
LoRa Frequency Accuracy \pm 10KHz
RoLa Transmission Power : 2~+20dBm
LoRa Data Rate : 0.244~18.2Kbps
LoRa Sensitivity : down to -137dBm
LoRa Communication Dist. : 2Km
AC Input Voltage : Single Phase, 110~277Vac / 50-60Hz
Max. Switching Load : Max. 1.2A @220Vac
Power Consumption : Max. 2W
Surge Protection : 4KV
Enclosure : IP66 (on NEMA Socket)
Dimensions : \varnothing 85 x 108mm
Weight : 215g
Storage Temperature : -20°C ~ +80°C
Operating Temperature : -10°C ~ +70°C
Operating Humidity : 0 ~ 95%



LoRa Converter SLC485

Industrial IoT LoRa Converter SLC485 Specifications

Main Chip

LoRa Transmission : Semtech SX1272

Soc : Cortex®-M0

Memory: Flash 128K

LoRa

Frequency: 862~932MHz

Frequency Accuracy: ± 10KHz

Modulation: LoRa

Transmit Power: 2~+20dBm

Data Rate: 0.244~18.2Kbps(LoRa)

High Sensitivity: down to -137dBm

Communication Distance: 2~5Km

Antenna Impedance: 50ohm

Serial Port

RS232/RS485:

-Half Duplex of RS232

Baud Rate to 9600 、 19200 、 38400 、 57600 、 115200bps

-Half Duplex of RS485

Baud Rate to 9600 、 19200 、 38400 、 57600 、 115200bps

Configurations and Management

Firmware: Com port support system firmware upgrade

Power Source

Supply Voltage: +5~24VDC Terminal Block

+5V Micro USB

(alternative)

Power Consumption

Standby: 5V,16.63mA

12V,6.97mA

24V,4.03mA

Transmission: 5V,17.35mA

12V,41.95mA

24V,21.73mA

Environment

Operating Temperature: 0°C~50°C

Mechanism

Dimensions: W*H*D: 27*89*68 (mm)

Weight: 82± 5g

Download Tool: <https://www.maxlong.com.tw/product-detail/slc485/>



LoRa Converter SLC922

LoRa Converter SLC922 Specifications

Main Chip

LoRa Transmission : Semtech SX1272

Soc : Cortex®-M0

Memory: Flash 128K

LoRa

Frequency: 862~932MHz

Frequency Accuracy: ± 10 KHz

Modulation: LoRa

Transmit Power: 2~+20dBm

Data Rate: 0.244~18.2Kbps(LoRa)

High Sensitivity: down to -137dBm

Communication Distance: 2Km

Antenna Impedance: 50ohm

Serial Port

RS232/RS485:

-1 port RS232 with DB9 or 1 port RS485
with TB5 (S/W Jump select)

-Half Duplex of RS232 Baud Rate to 9600 、
19200 、 38400 、 57600 、 115200bps

-Half Duplex of RS485 Baud Rate to 9600 、 1
9200 、 38400 、 57600 、 115200bps

DI/DO

125 Vac @0.5A, 24 Vdc @1A

Output: 1*Relay Dry Contacts, Terminal Block

Input: 1*Dry Contacts, Terminal Block

Data Rate: 0.244~18.2Kbps (LoRa)

High Sensitivity: down to -137dBm

Communication Distance: 2Km

Antenna Impedance: 50ohm

Configurations and Management

Firmware: Com port support system firmware upgrade

Power Source

Supply Voltage: +9~24VDC, Terminal Block

Power Consumption@12V: Max 3W

Environment

Operating Temperature: -20°C~70°C

Mechanism

Dimensions: W*H*D: 43*135*96 (mm)

Weight: 400 \pm 5g



SEW832-2 DIO

4G

IoT



Features

- Built-in MediaTek smart 7688
- Linux OpenWrt OS
- Wide Range Input Power (DC 9 ~ 32V)
- Edge Computer with Multiple I/O Interfaces
- Low Cost Solution or 4G IoT
- Ethernet + WiFi + 4G + Serial + DIO

Digital Input / Digital Output

- Digital Input * 2 Pins (Active High / Active Low Selectable)
Dry contact : Logic level 0 : close to GND , Logic level 1 : open
Wet contact : Logic level 0 : 0 ~ 3 V, Logic level 1 : 5 ~ 12 V
- Digital Output * 2 Pins (Active High / Active Low Selectable)
120VAC @2A, 240VAC @1A, 24VDC @3A

Mechanical & Environment

Operating Temperature : - 20 °C ~ 70 °C
Storage Temperature : - 25 °C ~ 80 °C
Dimensions : 180 * 120 * 35 mm (W * D * H)
Weight : 950 gm
RoHS : Compliant with RoHS

Power DC 9 ~ 32V, 1000mA 500mA@12V (Support DC Jack & Terminal Input)

LED SYS , WiFi, 4G

LAN-ACK, LINK , Serial 0 RX + TX

Serial 1 RX+TX, DO * 2 + DI * 2

Warranty Warranty period : 1 year

Order Information

WPC-832-4-DIO-4G : 4G Model

WPC-832-4-DIO : Without 4G

System

- CPU
- RAM
- ROM
- OS

Connectivity

- Ethernet 10 /100 M bps (Auto Detecting)
Built-in 1.5KV Magnetic Isolation
- WiFi 2.4G WiFi IEEE 802.11 b / g / n
Support AP / Station
- 4G LTE / NB-IoT(Optional)
*Mini-PCle : USB 2.0 for 4G / NB-IoT
*Nano SIM * 1

Interface USB2.0 (on PCB)

I2C Interface * 1 (For RTC)

SD Card Interface : micro SD card (For storage)

Serial Port

Port 1 : RS-232/422/485 * 1

Port 2 : RS-422/485 * 1

Speed : 300 bps ~ 230.4 K bps

Parity : None, Odd, Even, Mark, Space

Data Bit : 5, 6, 7, 8 ; Stop Bit : 1, 2

RS-232 Pins : Rx, Tx, GND

RS-422 : Rx+, Rx-, Tx+, Tx- (Surge Protect)

RS-485 : Data+ , Data- (Surge Protect)

15KV ESD for all signals

Console port : UART – RX+TX+GND

Others RTC : Real Time Clock * 1 (Battery Backup)

Buzzer * 1

Reset Button * 1

4G LTE Reset GPIO * 1



碩久科技有限公司
MaxLong Technology Co., Ltd

SAI140 Analog Input Modbus Gateway



TYPE Information

- AI-140-16 : 4~20 ma * 2 Channels, 0~10V * 2 Channels
- AI-140-16-A : 4~20 ma*4 Channels
- AI-140-16-V : 0~10V *4 Channels

Hardware

- ▶ CPU : 8-bit CPU
- ▶ RAM : 64K bytes SRAM
- ▶ ROM : 256K bytes Flash ROM

Analog Input

- ▶ 16 bits resolution
- ▶ Support 0~10V , 4~20 mA

Serial Port * 1 port

- ▶ Port : RS- 485 * 1 Port (Terminal Block)
- ▶ Speed : 300 bps ~ 115.2 Kbps
- ▶ Parity : None
- ▶ Data Bit : 8
- ▶ Stop Bit : 1
- ▶ Surge Protect

Support Modbus RTU

Watch Dog Function

Power Input : DC 9 ~ 24 V , 200mA @ 12VDC
support DC Jack & Terminal Block

LED Lamp : PWR , Rx , Tx

Environment

- Operating Temperature: -10°C ~ +70°C
- Storage Temperature : -20°C~ +85°C

Dimension : 90 * 60 * 20 mm (W * D * H)

Din-Rail and Panel mounting options

Regulatory Approval :

- ▶ CE / FCC
- ▶ RoHS

Warranty : 1 year



SDIO43 Modbus RTU with 4DI / 3DO



Serial Interface (to control DIO)

Port number :1/Port Type :RS-485

Connector :2-pin Terminal Block

Speed :9600 bps ~ 115.2 Kbps

Parity :None , Odd , Even

Data Bit : 8/Stop Bit :1 , 2

Protection :RS-485 Surge Protection Built in 15KV ESD protection for all signals

Digital I/O

Digital Input :4 (active High / Low selectable)

Digital Output :3 (active High / Low selectable)

DO x 3 : Relay output, 125V AC@0.5A, 30V DC@1A

DI x 4 : 3000 VDC Isolation Protect

Wet contact : Logic level 0 : 0 ~ ~32 V , Logic level 1 : 5 ~ 20 V

Dry contact Logic level 0 : close to GND

Logic level 1 : open

Features

- Act as a Modbus Slave device receiving command from Modbus Master
- Support 4 DI / 3 DO
- Utility support for configuration

Specifications

Hardware

CPU : 8 bits CPU

RAM : 2 KB SDRAM

ROM : 32 KB Flash ROM

Software Features

Protocol : Modbus RTU

OS Supported : Win 10

Configuration : Window Utility

Applications

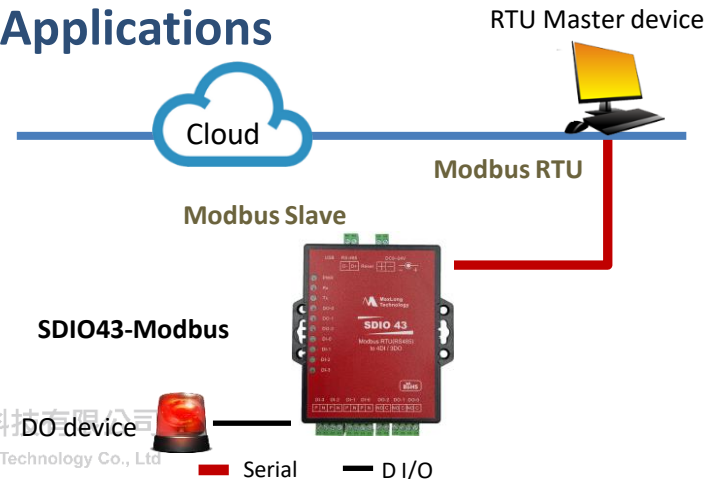

碩久科技有限公司
MaxLong Technology Co., Ltd

Serial DI/O

SE332 2-Port Serial To Ethernet Converter



Features

- Support Multiple TCP connections
- Support TCP Server / TCP Client / UDP / Virtual COM / Pairing
- Support DDNS, PPPoE
- Built in termination resistor
- Web Browser configuration
- Easy installation Windows utility
- On line F/W upgrade

Specification

Hardware

CPU :RISC CPU, 16 bits, 100 MHz,

RAM :2MB Internal SDRAM

ROM :256K bytes Flash ROM

Watchdog :Built in H/W Watchdog timer

Ethernet

Port number : 1

Port Type :RJ-45 Connector

Speed : 10 / 100 Mbps (Auto Detect)

Protocol : ARP, IP, ICMP, UDP, TCP, HTTP, DHCP, TELNET
DDNS, PPPoE

Mode : TCP Server / TCP Client / UDP / Virtual Com
/ Pairing

Setup : HTTP Browser Setup (IE, Chrome, Firefox)

Security : Login Password

Protection :Built-in 1.5KV Magnetic Isolation

Serial Interface

Port number :2

Port Type : RS-232 x 1 Port (DB9) ,
RS-422/485 x 1 Port (Auto Detect)

Connector : Male DB9 / 4-pin Terminal Block

Speed :110 bps ~ 230.4 Kbps

Parity :None , Odd , Even , Mark , Space

Data Bit : 5, 6 , 7 , 8/Stop Bit : 1 , 1.5 , 2

Port 1 RS-232 :Rx , Tx , GND , RTS , CTS , DTR , DSR ,
DCD

Port 2 RS-232 :Rx , Tx , GND

RS-422 :Rx+ , Rx- , Tx+ , Tx-

RS-485 :Data+ , Data-

Built-in :RS-422/485 pull high / low Resistor

Protection :422/485 Surge Protection

Built in 15KV ESD protection for all signals



碩久科技有限公司
MaxLong Technology

MG8322 Modbus Gateway



Specification

- Support Modbus TCP to Modbus RTU/ASCII Networks
- 4 Modbus modes selectable
- Support 1x Master or 1x Slave mode
- Web Browser configuration
- Easy installation Windows utility
- Watchdog function

System

- CPU: 32-bit ARM Cortex-M4 CPU, 120 MHz
- RAM: 128K bytes SRAM
- ROM: 512K bytes Flash ROM
- OS: μ Clinux OS

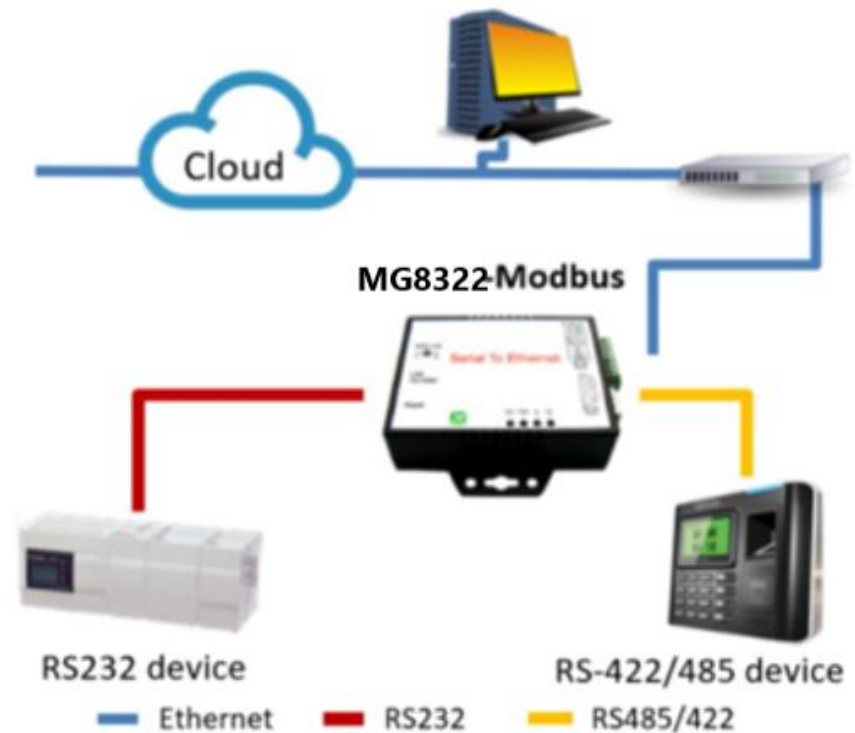

Ethernet

- Port number : 1
- Port Type : RJ-45 Connector
- Speed : 10 / 100 Mbps (Auto Detect)
- Protocol : ARP, IP, ICMP, UDP, TCP, HTTP, DHCP
- Mode : TCP Server / TCP Client / UDP / Virtual Com / Pairing
- Setup : HTTP Browser Setup (IE, Chrome, Firefox)
- Security : Login Password
- Protection : Built-in 1.5KV Magnetic Isolation

Serial Ports

- Port number : 2
- Port Type : RS-232 x 1 Port (DB9) ,
RS-422/485 x 1 Port (Auto Detect)
- Connector : Male DB9 / 4-pin Terminal Block
- Speed : 300 bps ~ 230.4 Kbps
- Parity : None , Odd , Even , Mark , Space
- Data Bit : 5, 6 , 7 , 8
- Stop Bit : 1 , 2
- Port 1 RS-232 : Rx , Tx , GND
- Port 2 RS-422 : Rx+ , Rx- , Tx+ , Tx-
RS-485 : Data+ , Data-
- Built-in : RS-422/485 pull high / low Resistor
- Protection : 422/485 Surge & Over Current Protection
- Built in 15KV ESD protection for all signals

Software Features

- OS Supported : Windows 2000/2003/XP/Vista/Win 7/8/10
- Configuration : Window Utility, Web Browser
- **Support** Modbus TCP To Modbus RTU / ASCII Slave, Modbus RTU / ASCII To Modbus TCP Slave

Warranty

- Warranty period : 1 year.

Other Features

- **LED:** SYS (PWR), DI/DO, Port-2, Port-1
- Built in H/W Watchdog timer

Power

- Input: DC 9 ~30V, 300mA@ 12VDC
- Consumption < 4W
- DC Jack & 2-pin Terminal Block.

Mechanical and Environment

- Dimensions: 90 * 60 * 25 mm (W * D * H)
- Temperature : Operating: 0°C ~ 70°C (32°F ~ 158°F)
Storage: -20°C ~ 80°C (-4°F ~ 176°F)
- Humidity : Operating: 10% ~ 95% non-condensing
Storage: 5% ~ 95% non-condensing

SEW832 2-Port Modbus TCP to Modbus



Specification

Hardware

- CPU : MT7688AN MIPS CPU, 580 MHz
- RAM : 128M Bytes DDR2 RAM
- ROM : 32M Bytes Flash ROM
- OS : OpenWrt Linux OS

Serial Ports *2

- Port : RS-232 *1
- Port : RS-422 / 485 *1 (Surge Protect)
- Speed: 300 bps ~ 921.6 K bps
- Parity: None , Odd , Even
- Data Bit: 5 , 6 , 7 , 8
- Stop Bit : 1 , 2
- RS-232 Pins : Rx , Tx , GND
- RS-422 : Rx+ , Rx- , Tx+ , Tx- (Surge Protect)
- RS-485 : Data+ , Data- (Surge Protect)
- 15KV ESD for all signals

Features

- TCP to RTU support 8 simultaneous TCP Master,
- RTU to TCP support 8 TCP Slaves on each port.
- Software support :
TCP to RTU Slaves, RTU to TCP Slaves,
TCP to ASCII Slaves, ASCII to TCP Slaves
- Supports 802.11b/g/n and Ethernet, Two Ips
- Web Browser configuration
- Easy installation Windows utility
- On line F/W upgrade

Ethernet

- Port Type : RJ-45 Connector
- Speed : 10 /100 M bps (Auto Detecting)
- Protocol: ARP, IP, ICMP, UDP, TCP, HTTP, DHCP,
- Protocol: DNS, NTP
- Mode : TCP Server / TCP Client / UDP
- Setup : HTTP Browser Setup (IE, Chrome, Firefox)
- Security : Setup Password
- Protection : Built-in 1.5KV Magnetic Isolation

WiFi

- Tx Power 11b : Max. 22dBm
- Tx Power 11g/n : Max. 19dBm
- Rx Sensitivity : -76dBm@54Mbps; -
89.5dBm@11Mbps
- Tx Rate : Max. 54Mbps with auto fallback
- Tx Distance : Up to 100m



SLDIO201 LoRa Digital I/O Controller



Specification

● Digital I/O

- Digital Input * 2 3000VDC Isolation Protect (Active High /Active Low Selectable)
Dry contact : Logic level 0 : close to GND ,
Logic level 1 : open
Wet contact : Logic level 0 : 0~3 V ,
Logic level 1 : 10 ~ 30 V
- Digital Output * 2
Relay (Active High /Active Low Selectable)
120V AC@10A , 240V AC@7A , 24V DC@10A
- Setup Tool : Windows Utility
- Power : DC 9 ~ 24V / 150ma @ 9V , 60ma @ 24V
- Led Lamp : SYS (red) , Pairing (green) , Rx(red) , Tx(green)
- Environment: Operating Temperature:-10°C~70°C
Storage Temperature:-20°C~85°C
- Dimensions : 160 * 90 * 25 mm (W * D * H)
- Weight : 350 gm (not include power)

- LoRa Digital I/O Controller
- CPU : 32 bits MCU ,40 MHz , 16KB SRAM, 128KB Flash ROM
- Support Modbus Protocol
- **LoRa** : Semtech SX1272
 - Freq. : ISM band 862 ~ 936MHz
 - Receiver Sensitivity : -137 dBm
 - Transmit Output Power : 20 dBm
 - Sleep Current : 3uA (at power down state)
 - TX current < 140 mA@20 dbm , RX current < 10 mA
 - Security processor (128/192/256 bits AES)
 - Packet engine up to 256 bytes with CRC
 - Antenna : SMA Type , 2 dBi , changeable
 - Distance : Up To 5000 Meters in free space
 - Data Rate : 0.244 ~ 18.2K bps (LoRa) / 300 K bps (FSK)
 - Application mode : Star

SIO332-10DI 10DO

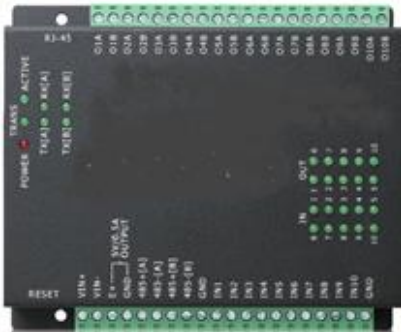

TCP remote 10 DI / 10 DO Controller work with http and Modbus commands

System

- CPU : 16 bits, 100 MHz
- RAM : 2MB SDRAM
- ROM : 512KB ROM
- Watchdog

DI / DO

- Mode : TCP Server / TCP Client / UDP
- 10 isolated DI, 10 isolated DO
- DI/DO Isolation 2500VDC
- DI Overload protection 70VDC, dry contact
- DO Contact rating: AC 120V@0.5A, DC 30V@1A.
- DO Transformation time: 10msec.
- I/O mapping settings
- E-mail Alert

Mechanical and Environment

- Operating Temperature : -0°C ~ 65°C
- Storage Temperature: -20°C ~ 85°C
- Humidity: 5~95%RH
- Dimensions : 135 * 115 * 35 mm (W * D * H)
- Weight : 525 ± 5gm

Power

- DC 9~30V, 500mA Terminal Input

Features

- TCP remote controlled 10 DI / 10 DO
- Web Browser configuration
- LED status indication
- E-mail Alert
- Easy installation Windows utility
- On line F/W upgrade
- Support CGI & Modbus TCP/RTU commands

Ethernet

- Port Type : RJ-45 Connector
- Speed : 10 /100 M bps
- Protocol: ARP, ICMP, TCP, HTTP, IP, DHCP,
- Protocol: DNS, NTP, PPPoE
- Mode : TCP Server / TCP Client / UDP
- Setup : HTTP Browser Setup (IE, Chrome, Firefox)
- Security : Setup Password
- Protection : Built-in 1.5KV Magnetic Isolation
- Maximum sessions: 3

Serial Ports (#B)

- Port : RS-485 *1
- Speed: 1200 bps ~ 230.4K bps or user defined
- Parity: None , Odd , Even, Mark, Space
- Data Bit: 5 , 6 , 7 , 8
- Stop Bit : 1 , 2
- RS-485 : Data+ , Data-
- RTS/CTS, XON/XOFF

Other Features

- Led Lamp : POWER, ACTIVE, RX, TX, LAN

Warranty

- Warranty period : 1 year.

ModbusLoRa AI (SLAI 140)



- > Plug and play
- > Easy to set up
- > 0-10V 2ch 4-20mA analog in put
- > Simple construction maintenance and operation
- > Instant return (NO waiting time)
- > Indoor/Outdoor models are complete
- > Complete indoor and outdoor antenna available

Communication technology : LoRa 862~932 MHz pass through mode or Modbus. (non-LoRa WAN protocol)

Transmission mode : Multi-end points form a broadcast network according to the frequency band, and only one end point can send signals at a time (similar to the traditional Walkie-talkie design), only suitable for one Master+n Slaves applications.

Communication Flow : Maximum load 255 bytes per packet data.

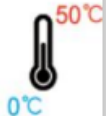

ModbusLoRa AI Specifications

LoRa Main Chip

LoRa Transmission : Semtech SX1272

Soc : Cortex® -M0

Memory: Flash 128K

Frequency: 862~932MHz

Frequency Accuracy: ±10KHz

Modulation: LoRa

Transmit Power: 2~+20dBm

Data Rate: 0.244~18.2Kbps(LoRa)

High Sensitivity: down to -137dBm

Communication Distance: 2~5Km

Antenna Impedance: 50ohm

Analong Main Chip

CPU : 8-bit CPU

RAM : 64K bytes SRAM

ROM : 256K bytes Flash ROM

Memory: Flash 128K

4~20 mA * 2 Channels

0~10V * 2 Channels

16 bits resolution

Power Source

Supply Voltage: +9~24VDC Terminal Block

Power Consumption

Standby: 12V, 6.97mA

24V, 4.03mA

Transmission: 12V,41.95mA

24V,21.73mA

Environment

Operating Temperature: -10°C~60°C

Mechanism

Dimensions: W*H*D: 27*89*68 (mm)

Weight: 100 ±5g

>> www.maxlong.com.tw



碩久科技有限公司
MaxLong Technology Co., Ltd

SKY AH100

網路延伸器



規格 / 使用說明

1. SKY AH100 產品 在低於1GHz的免許可證頻段內構建遠程超低功耗WiFi網絡。 AH100支持兩種操作模式，即AP模式和STA。通過模式選擇按鈕，用戶可以輕鬆設置AH100的操作模式。為了便於使用和安裝， AH100提供了配對按鈕來建立WiFi網絡，而不是進行複雜的手動設置。
2. 一個AP可以同時支持多個STA連接。 STA的總數取決於傳輸量和應用。因此，採用適當數量的STA以獲得最佳整體性能。

Specification

Frequency	915MHz (US) (902MHz~928MHz)
Modulation	OFDM with BPSK, QPSK, 16QAM, 64QAM
Data Rate	150Kpbs ~ 15Mbps
Channel Bandwidth	1/2/4/8 MHz
Antenna Connector	SMA
Interface	RJ45
LED	PWR x 1 / Connect x 1 / RSSI x 3
Button	AP/STA Mode x 1 / Pairing x 1
DC Jack	5V~12V@1A
Operating Temperature	-20~70°C
Storage Temperature	-30~70°C

Accessory

Antenna	Dipole antenna with peak gain 2dB
---------	-----------------------------------

Appearance

The appearance of SKY AH100 is shown as below.



1. LED PWR : red, power on
2. LED CONNECT : green, connection links up
3. LED RSSI : blue, RF signal strength
4. DC Jack
5. Pairing Button
6. AP/STA Mode Button: press the button to AP mode, otherwise, the device is in STA mode
7. SMA Connector
8. RJ45 Connector

Quick Test of Bridge

To quick test the connection of SKY AH100, set up the test environment as Figure 4.

1. Check the LED "CONNECT" to see if the connection has been established.
2. Check NB' s IP address that is got from AP Router.
3. Use PING command to query the IP address of AP Router.

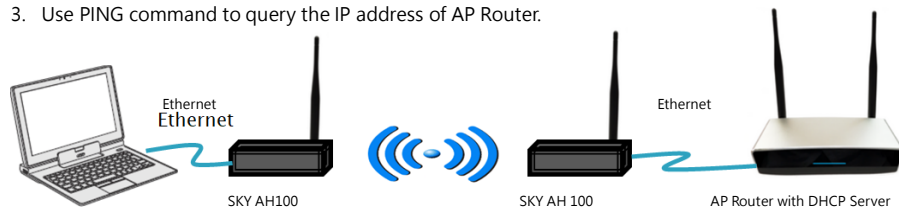

碩久 隔離器

產品特性

1. 異質介面跨接保護
2. 機台Sensor的信號輸出一般不會太大，SMB的信號截取也會分掉一定的電流量，故設計安裝在Sensor與SMB之間的保護隔離器有設計分流的調整裝置，避免影響機台原生控制器，不會造成動作誤判
3. NOP1產品同時具備光耦合隔離及可控制電流分流量
4. NOP4具備光偶和隔離共陰共陽

單通道隔離器(NOP101) Dix1



參數	
輸入迴路	1CH
承受信號電壓(備註1)	2.7~60V
消耗電流	1.13mA (max)
輸出信號開集極負載	open collector 2V-35V,50mA (Max)
隔離保護電壓	5000Vrms
輸入端極性保護	No
輸入逆電壓保護電壓	100V
輸出逆電壓保護電壓	40V
操作環境	-10~60°C / 0~95%RH, non-condensing
儲存溫度	-20~70°C
尺寸	69.25(L)*6.9(W)*11.2(H)mm

**備註 (1) 先順時針VR1調整至最大後再輸入電壓60V，否則燒毀。

使用方法:

- 1.先順時針VR1調整至最大後再接上輸入端信號。
- 2.觸發輸入端信號(此時輸出端可能尚未能輸出信號)。
- 3.微幅逆時針調整VR1到輸出端得到信號得到信號後再超過一點即可。
- 4.如調整過多造成信號過大則可能導致擊穿燒毀。
- 5.套上熱縮膜固定接頭並保護VR參數。



四通道隔離器(NOP104)Dix4

參數	
輸入迴路	4CH
承受信號電壓(備註1)	2.7~38V
消耗電流	10.25mA (max)
輸出信號	open collector (開集極) 2V-35V,50mA (Max)
自帶極性保護電路	可接受共陰或共陽
隔離保護電壓	5000Vrms
輸入端極性保護	Yes
輸入逆電壓保護電壓	100V
輸出逆電壓保護電壓	40V
操作環境	-10~60°C / 0~95%RH, non-condensing
儲存溫度	-20~70°C
尺寸	69.25(L)*18.4(W)*13(H)mm

**備註(1) 輸入電壓38V超過則燒毀

使用方法:

- 1.要確認輸入的4個信號源要能共陰或共陽。
- 2.留意輸入信號過大可能導致擊穿燒毀。
- 3.套上熱縮膜固定接頭。

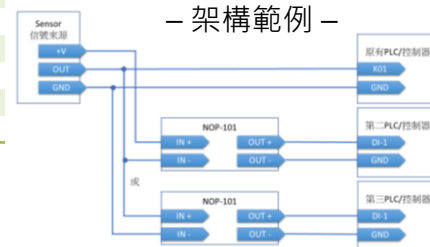

LoRa Sensor裝置



PM2.5



溫溼度



CO2



CO



VOC



土壤溫溼度+EC +土壤pH值 感測器



土壤溫溼度、土壤容積含水率、土壤電導率 (EC 值) 、土壤pH值 感測器



技術參數:

測量參數：土壤溫度，土壤容積含水率，土壤電導率 (EC 值)，土壤 pH值

測量單位： $^{\circ}\text{C}$ ；%(m³/m³)； $\mu\text{S}/\text{cm}$ ；pH

溫度量程： $-30\sim 70^{\circ}\text{C}$ (可定做 $0\sim 50^{\circ}\text{C}$ 或其他任意量程)

水分量程： $0\sim 100\%$ (可選擇 30%，50%等量程或定做任意量程)

電導率量程： $0\sim 2000\mu\text{S}/\text{cm}$ ， $0\sim 10000\mu\text{S}/\text{cm}$ ， $0\sim 20000\mu\text{S}/\text{cm}$

pH 值量程： $3\sim 10\text{pH}$

測量精度： $\pm 0.2^{\circ}\text{C}$ ； $0\sim 50\%$ (m³/m³)

範圍內為 $\pm 2\%$ (m³/m³)； $\pm 2\%$ ； $\pm 0.2\text{pH}$

分辨率： 0.1°C ； 0.1% ； $1\mu\text{S}/\text{cm}$ ； 0.01pH 輸出信號：RS485 (標準 Modbus-RTU

協定，設備預設位址：01)

供電電壓： $7\sim 24\text{V DC}$

工作範圍： $-30^{\circ}\text{C}\sim 70^{\circ}\text{C}$

穩定時間：通電後 3秒, 回應時間 < 1 秒

物理參數:

探針材料：316L 不銹鋼密封材料：ABS 工程塑料，環氧樹脂，防水等級 IP68電纜

規格：標配 2 米 (可定制其他電纜長度，最長 1200 米)

戶外型溫溼度感測器 MTH-503S4D



- 信號反應速度快，精確度高，重現性好，穩定性佳
- 採微電子電路設計，精巧、省電、抗雜訊
- Modbus RTU 通訊協定
- 提供 LoRa 無線傳輸選擇，安裝更簡便
- 採用工業等級的防護外殼，可使用於戶外環境
- CE、FCC 認證

MTH-503S4D溫溼度感測器，採用高精度溫溼度感測元件，及微型電子電路設計，穩定性高，適用於商業大樓、辦公室、機房、飯店或住家等的空調系統。本感測器除具有多種輸出信號外，亦可搭配 LCD 液晶顯示器，可做現場同步顯示之用。在安裝方式上，提供壁掛式、風管式、外氣式及分離式，可依現場環境狀況，選擇適用的款式。

產品型號	MTH-503S4D
量測功能	溫度 + 溼度
信號輸出	4~20mA, 0~10V/0~5V/1~5V, RS485, LoRa (P to P) 適用頻率: 868.0 ~ 912.9 MHz
安裝方式	壁掛式/ 風管式/ 外氣式/ 分離式
負載電阻	電流輸出: RL < 500Ω at 24V DC/ 電壓輸出: RL > 2.5KΩ at 24V DC
電壓/電流輸出(值域範圍選擇)	T: 0~100°C, 0~50°C, -50~+50°C H: 0~100%RH T: -40°C~100°C
RS485/LoRa 輸出(值域範圍)	H: 0~100%RH A: T: ±0.2°C H: ±2%RH B: T: ±0.3°C H: ±3%RH
精確度(at 25°C/55%RH)	
感測元件	CMOSens sensor
反應時間	< 10 sec. (20% to 80% of range)
防潮等級	壁掛式: IP30; 風管式/外氣式/分離式: IP65
LCD 顯示	選配
電源供應	DC 12 ~ 36V (輸出信號 0~10V/0~5V/1~5V, RS485/LoRa); DC 15 ~ 36V (輸出信號 4~20 mA); AC 24V(50/60HZ) 壁掛式: 113.57(H)x80.00(W)x28.79(D); 風管式/外氣式/分離式: 137.5(H)x99.0(W)x40.4(D); 探頭長度: 風管式 Ø15x300.0、外氣式 Ø15x60.0; 分離式線材長度 3360
尺寸(mm)	
感測器外殼材質	防火型ABS
戶外防水盒材質	PVC
戶外防水盒重量	530g
使用環境溫度	溫度: -20 ~ +60°C; 溼度: 0 ~ 95%RH (無結露)
認證	CE, FCC

戶外防水盒尺寸

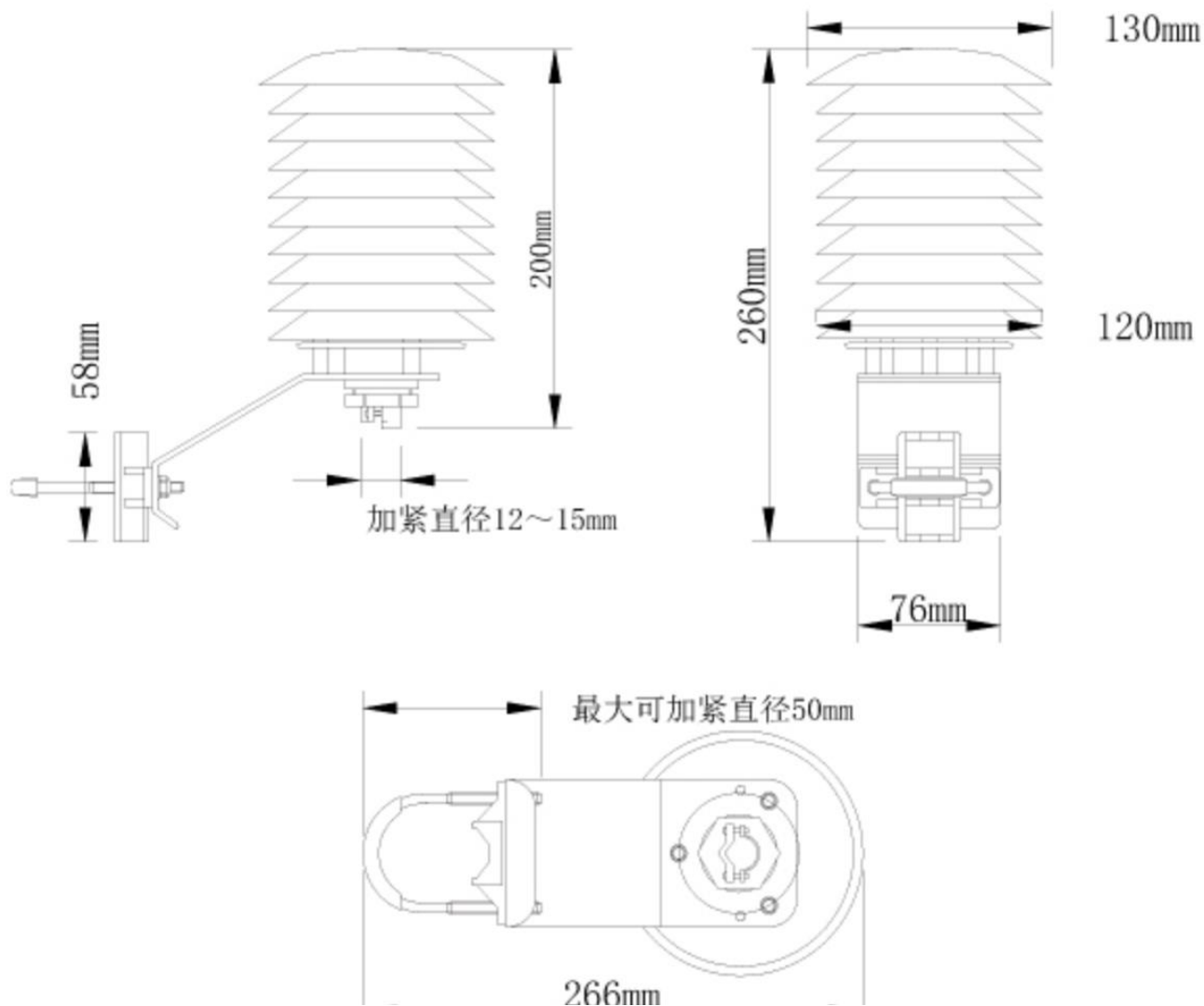

戶外型多合一氣體感測器 MTG300-08

特點

1. 具有高靈敏度、快速響應、可有效抗水蒸氣、高穩定性、使用壽命長等特性。
2. 採用高精度數據採集芯片，先進的製造工藝和表面貼裝技術，確保測量數據準確可靠。
3. 適用於大部分通用環境感測，監測參數齊全，數據準確。
4. 監測參數可根據要求訂製，最多5-6個參數(包括空氣溫度、空氣濕度、CO₂濃度、CO濃度、甲醛、氧氣、PM_{1.0}/2.5/10.0、大氣壓力、臭氧、揮發性有機物，空氣質量等)。



Technical Specification

Item	Technical Specification		
	Range	Resolution	Accuracy
Temperature	-30°C~70°C	0.1°C	±0.2°C
Humidity	0~100%RH	0.1%RH	±3%RH
Illuminance	0~200K Lux	10 Lux	±5%
Dew point temperature	-100°C~40°C	0.1°C	±0.3°C
Air pressure	600~1100hPa	0.1hPa	±0.5hPa
CO ₂	0~5000ppm	1ppm	±75ppm+2%rdg
Civil CO	0~500ppm	0.1ppm	±2%FS
PM1.0/2.5/10	0~1000µg/m ³	1µg/m ³	±3%FS
TVOC	0~5000ppb	1ppb	±3%
CH ₂ O	0~5000ppb	10ppb	±3%
O ₂	0~25%VOL	0.1%VOL	±2%FS
O ₃	0~10ppm	0.01ppm	±2%FS
Air quality	0~10mg/m ³	0.05 mg/m ³	±2%FS
NH ₃	0~100ppm	1ppm	±2%FS
H ₂ S	0~100ppm	1ppm	±2%FS
NO	0~250ppm	0.1ppm	±3%FS
NO ₂	0~20ppm	0.1ppm	±2%FS
Odour	0~50ppm	0.01ppm	±2%FS
SO ₂	0~20ppm	0.1ppm	±2%FS
Cl ₂	0~10ppm	0.1ppm	±2%FS
Civil gas	0~5000ppm	50ppm	±3%LEL
Supply	12-24VDC		
Output	RS485		
Warm Up Time	3min		
Response Time	<1s		
Stability	<±1%FS		
Repeatability	<±2%FS		
Operating Temperature	-20°C~+60°C@15-80%RH		
Storage	-40-70°C@20%-90%RH		
Shell Material	ABS		

DIMENSION

Unit:mm

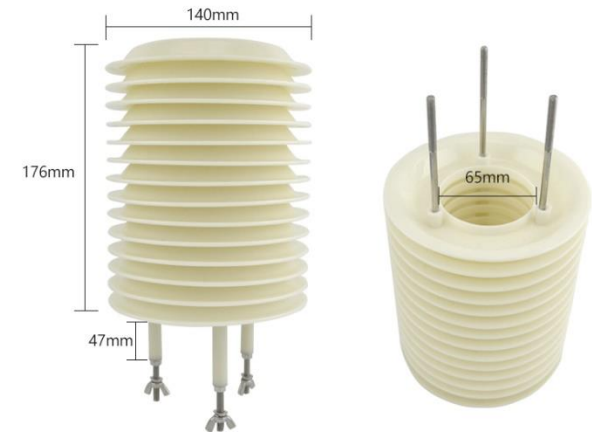

PM1.0/2.5/10粉塵+溫溼度感測器 PM1250

特點

1. 具有高靈敏度、快速響應、可有效抗水蒸氣、高穩定性、使用壽命長等特性。
2. 採用高精度數據採集芯片，先進的製造工藝和表面貼裝技術，確保測量數據準確可靠。
3. 適用於大部分通用環境感測，數據準確。
4. 監測參數包括PM1.0/2.5/10.0。



Technical Specification

Item	Technical Specification		
	Range	Resolution	Accuracy
Temperature	-30°C~70°C	0.1°C	±0.2°C
Humidity	0~100%RH	0.1%RH	±3%RH
PM1.0/2.5/10	0~1000µg/m3	1µg/m3	±3%FS
Output	RS485		
Warm Up Time	3min		
Response Time	<1s		
Stability	<±1%FS		
Repeatability	<±2%FS		
Operating Temperature	-20°C~+60°C@15-80%RH		
Storage	-40~70°C@20%-90%RH		
Shell Material	ABS		

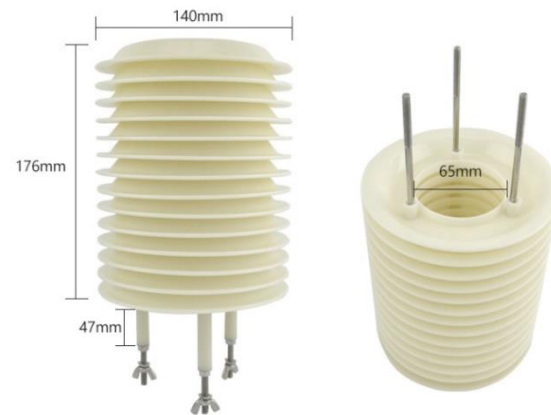

經濟型雨量感測器 MR400-04



MR400-04雨量感測器是一種水文氣象測量儀器，用於測量降雨量，並將降雨量轉換為脈衝信號輸出。採用防蟲網設計，防止堵塞噴嘴，內置水準泡。該感測器可用於氣象、水文、農業、林業、野外監測站等行業。配合資料記錄儀可對降雨、降雨強度、降雨時長進行測量。

Specification

參數	技術指標
承雨桶	直徑：φ200mm，高度：271mm
實測降雨強度	最大：4mm/min
允許降雨強度	最大：8mm/min
解析度	0.2mm
精度(2mm/min)	±4%
最大負載電壓	30VDC (脈衝輸出)
最大負載電流	20mA
輸出	脈衝 (@10kΩ&0.01uF)，RS485 (12-24VDC供電)
工作溫度 (無凝結)	0-60°C@0%-100%RH
材質	雨量桶和翻斗：ABS， 支撐腿：304SS
重量 (淨重)	2kg

產品特色

- 體積小巧，使用方便。
- 精度高，穩定性好。
- 承雨口設計有濾網，防止樹葉和昆蟲等碎片進入雨量感測器工作。
- 製作精良，阻力小。
- 主體採用高強度ABS材料製成。
- 底部水準泡。
- 插座帶防蟲網。

產品應用

- 氣象監測。
- 水文監測。
- 自然災害監測。
- 農業氣象研究。
- 氣候研究。



光照度感測器MI201-01



MI210-01照度感測器是一款具有高靈敏度，可以檢測微弱光源，測量範圍廣，精度高，防水性能好，使用簡單，易於安裝的感測器。應用範圍廣，尤其適用於農業溫室，城市照明等場合。

- 高靈敏度。
- 適用於各種惡劣環境。
- 精度高，測量範圍廣。
- 體積小巧。
- 安裝簡便。

- 農業氣象。
- 智能建築。
- 溫室控制。
- 氣象站。
- 作物監測。

Specification

參數	技術指標	
量程	0-2000lux, 0-20klux, 0-200klux 可選	
光譜範圍	380-780nm	
供電	5VDC, 12-24VDC	
輸出	4-20mA, 0-5V, 0-10V	RS485
精度	<±5%FS	<±4%FS
回應時間	1s	
溫度飄移	±0.2%/°C	
重複性	<1%FS	
顯示	LCD 可選 (ABS外殼)	
操作溫度	-40°C +75°C	
重量 (淨重)	170g	
外殼材質	ABS或金屬外殼可選	

噪音感測器MS300-06



噪音感測器是一種數位化、模組化的多功能聲級計。採用數位信號處理晶片和數位檢測技術，具有可靠性高、穩定性好、頻段寬、無需切換量程等特點，可廣泛應用於各種機器、車輛、船舶、電器等工業噪音測量，也可用於環境噪音測量、勞動保護、工業衛生等行業。

Specification

參數	技術指標
量程	30-130dB
精度	$\pm 3\text{dB}@23\pm 5^\circ\text{C}$ ，94dB(1kHz)時，符合IEC 61672標準2類
回應頻段	31.5Hz - 8kHz.
連接器	B&K 4226
麥克風	電容式麥克風，尺寸：0.5 inch
供電	5VDC, 12-24VDC
防護等級	IP65
輸出	RS485, RS232
功耗	<20mW
回應時間	<200ms
操作溫度	-10°C - +50°C @5-80%RH
儲存環境	-40-70°C @20%-90%RH
外殼材質	ABS & 鋁合金

- 靈敏度高。
- 回應快速。
- 功耗低。
- 穩定性好。
- 使用壽命長。

- 環境品質監測。
- 智能家居。
- 倉儲。
- 公共場所。
- 勞動保護。
- 畜牧業。

產品特色

產品應用

Two-Button

SIP Video Door Phone

SKY-83

HD Audio
1080P HD Camera
Unlock door with DTMF



1080P



HD



PoE



Overview

The SKY-83 is an Two-button SIP Door Phone with the integrated HD camera and advanced audio system. It supports H.264 video compression format and delivers excellent video quality in 1080p video resolutions. with the DP73 touch screen control pad, you can speak to visitors and view video from camera at any time.

The SKY-83 offers keyless control and convenience for the users opening the door without a key. The door can be open remotely if there is an electronic door lock. It's ideal for control communication and security over internet such as business, institutional and residential applications .



碩久科技有限公司
MaxLong Technology Co., Ltd

Video Features

- 3M Pixels color CMOS camera
- Maximum image transfer rate: 1080p -30fps
- Video Codec: H.264
- Resolution: up to 1280 x 720
- Viewing Angle: 80° (H), 60° (V)
- Minimum Illumination: 0.1lux

Access Control

- Dual SIP line, Dual SIP servers
- Door Access: DTMF tones
- Door Phone features:
- Full-duplex
- Default auto answer
- Action URL/Active URI remote control
- Speed Dial

Administration Features

- Auto provisioning:
FTP/TFTP/HTTP/HTTPS/PnP
- HTTP/HTTPS Web Management
- Configuration keypad-based management
- SNMP/TR069
- NTP/Daylight Saving Time
- Firmware Upgrade via Web
- Syslog
- Configuration backup/restore

Environments

- Operating Temperature: -20~65 °C
- Storage Temperature: -40~70 °C
- Relative Humidity: 10~90%

Audio Features

- HD voice
- Two-way audio stream
- Wideband codec: G.722
- Narrowband codec: PCMA, PCMU,
G.729, G723_53, G723_63, G726_32
- Echo cancellation with G.168
- Voice activity detection (VAD)
- Comfort noise generator(CNG)
- Built-in Micro and speaker
- Acoustic echo cancellation audio output

Protocols & Network

- SIP v1 (RFC2543), v2 (RFC3261)
- SIP over TLS, SRTP
- RTSP
- TCP/IPv4/UDP
- RTP/RTCP, RFC2198, 1889
- HTTP/HTTPS/FTP/TFTP
- ARP/RARP/ICMP/NTP
- DNS SRV/ A Query/NATPR Query
- Primary /Secondary DNS
- STUN, Session timer
- 802.1p/q, DSCP,802.1x
- DHCP/Static/PPPoE
- DTMF Mode: In-Band, RFC2833 and SIP INFO

Physical Specifications

- 2 call button
- Aluminum surface, Metal bottom shell
- Power Supply: DC 12V1A or 802.3af PoE
- Power Requirements: 802.3af PoE class 3
- IEEE 802.3af Power-over-Ethernet
- 1xRJ45 10/100M Ethernet jacks
- Wall-mounted installation
- Dimensions: 200*120*38 mm



Physical Interface

- 1 port 100M/10M RJ45 Ethernet, POE
- 1 port Ethernet camera interface, support H264/H265
- 2 ports delay output
- 2 ports sensor short circuit input
- 2 ports exit button
- 1 port recording output
- 1 port 8Ω speaker
- 1 port analog audio output
- 1 port external audio input
- 1 port MIC
- 1 port tamper proof detection
- 1 port weigand card reader
- 1 port RS232
- 2 ports DSS key





5G

AI

IoT

Features

- Built-in Raspberry Pi CM4
- Wide Range Input Power (DC 9 ~ 32V)
- Multiple I/O Interfaces
- Powerful Computing capability
- CPU Heatsink Transfer Heat To Metal Housing
- M.2 key B for 5G (Default)
- M.2 key M for PCIe SSD / AI (optional)
- Mini-PCIe (for 4G/NB-IoT/LoRa)

Order Information

SG2245

SG2245-5G

SLG2245 LoRa

SLG2245-5G

SG2245 多功能控制器

高性能

核心採用工業用Broadcom BCM2711，具有4核心運算能力，可執行AI極大資料邊緣運算。

大彈性

可
搭
配

1. LTE 4G/5G模組達到高傳輸、低延遲，滿足場域應用。
2. LoRa模組，成為LoRa 控制器，收集Local資料後，透過行動網路與雲端通訊。
3. USB 3.0 可以接AI神經棒做高速運算。

多功能

具有 2 個 網路，2 個 RS232 或 2 個 RS485 及1個DO，5個DI，滿足各場域不同需求。



碩久科技有限公司
MaxLong Technology Co., Ltd

System

CPU	Broadcom BCM2711 QuadCore Cortex A72 (ARM v8) 64 bits SoC @ 1.5G
RAM	2 G Bytes LPDDR4 SDRAM
ROM	8 G Bytes EMMC Flash Memory
GPU	VideoCore VI (OpenGL ES 3.0, H.265 HEVC (4Kp60fps decode), H.264(1080p60fps decode)
OS	Linux OS

Connectivity

Wireless	Wifi 802.11b / g / n / ac (2.4/5GHz) (optional) Bluetooth 5.0 BLE (optional)
5G	M.2 key B USB 3.0 / PCI-E for 5G (optional)
4G	Mini-PCIe : USB 2.0 for 4G / NB-IoT / LoRa · (optional) Nano SIM Slot for 5G / 4G / NB-IoT
Ethernet	10/100/1000 Mbps Giga Lan * 1 (RJ45) · 10/100Mbps * 1 (RJ45)

Interface

USB 3.0 * 2, USB 2.0 * 2 · (optional) M.2 key M for PCIe SSD

Serial Port

Port 1: RS-232/422/485 * 1 · Port 2: RS-232/485 * 1

Digital Input / Digital Output

Digital Input	Digital Output
Digital Input * 5 Pin (Active High / Active Low Selectable) Dry contact : Logic level 0 : close to GND , Logic level 5 : open Wet contact : Logic level 0 : 0 ~ 3 V, Logic level 1 : 10 ~ 30 V	Digital Output * 1 Pin (Active High / Active Low Selectable) 120VAC @0.5A, 240VAC @0.25A, 30VDC @1A

Video Output

Micro HDMI * 1 (4Kp60fps with audio)

Mechanical & Environment

Operating Temperature: - 20 °C ~ 75 °C	Dimensions : 170 * 110 * 30 mm (W * D * H)
Storage Temperature: - 25 °C ~ 80 °C	Weight : 950 gm Housing : Metal.

Power

DC 9~32V, 1000mA@12V (DC Jack or Terminal Input)

LED

PI PWR / EMMC / Serial / DI / DO / SYS-Customer defined / 5G / 4G

Othe

rs RTC : Real Time Clock * 1 (with Battery) Buzzer * 1 Watch Dog Timer	Reset Button * 1 MIPI CSI 2-lane * 1 (optional) Fan - DC 12V (optional)
--	---

Warranty

Warranty period : 1 year



樹莓派 計算模組核心板底板 Compute Module 4 I/O Board

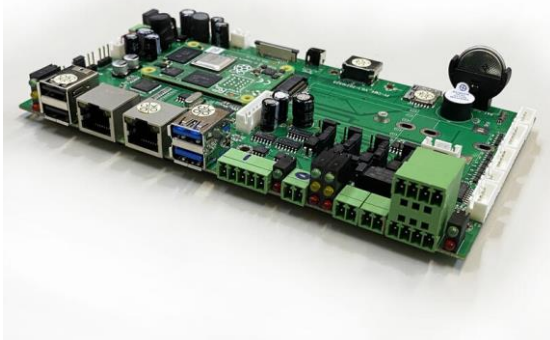

產品特色

Compute Module 4 IO Board 是一款可搭配樹莓派 Compute Module 4 使用之底板，可用作 Compute Module 4 之開發系統，以及作為嵌入式電路板集成到終端產品中，亦可使用現成的部件 (如PCIe 模組) 快速創建系統。

產品應用

Embedded Design & Development, Electronics Design, Industrial, IIoT (Industrial Internet of Things), IoT (Internet of Things)

Connectivity

Wireless	Wifi 802.11b / g / n / ac (2.4/5GHz) (optional) Bluetooth 5.0 BLE (optional)
5G	M.2 key B USB 3.0 / PCI-E for 5G (optional)
4G	Mini-PCIe : USB 2.0 for 4G /NB-IoT / LoRa ,(optional) Nano SIM Slot for 5G /4G/NB-IoT
Ethernet	10/100/1000 Mbps Giga Lan*1 (RJ45) , 10/100Mbps * 1 (RJ45)

Interface

USB 3.0* 2, USB 2.0 * 2 , (optional) M.2 key M for PCIe SSD

Serial Port

Port 1:RS-232/422/485 *1 , Port 2: RS-232/485 *1

Digital Input

Digital Input * 5 Pin
(Active High / Active Low Selectable)
Dry contac
Logic level 5 : open
ct : Logic level 0 : close to GND
Wet contact : Logic level 0: 0 ~ 3 V.
Logic level 1: 10 ~ 30 V

Digital Output

Digital Input * 1 Pin
(Active High / Active Low Selectable)
120VAC @0.5AA, 240VAC @0.25A
30VDC@IA

Mechanical & Environment

Operating Temperature	- 20 °C ~ 75 °C
Storage Temperature	- 25 °C ~ 80 °C
Dimensions	170mm x 110mm (W x D)

Power

DC 9~32V, 1000mA@ 12V (DC Jack or Terminal Input)

LED

PI PWR/EMMC /Serial / DI / DO / SYS- Customer defined / 5G / 4G

Others

RIC : Real Time Clock* 1 (with Battery)	Reset Button*1
Buzzer*1	MIPI CSI 2-lane*1(optional)
Watch Dog Timer	Fan - DC 12V (optional)

Warranty

Warranty period : 1 year

樹莓派 計算模組核心板底板 接口簡介

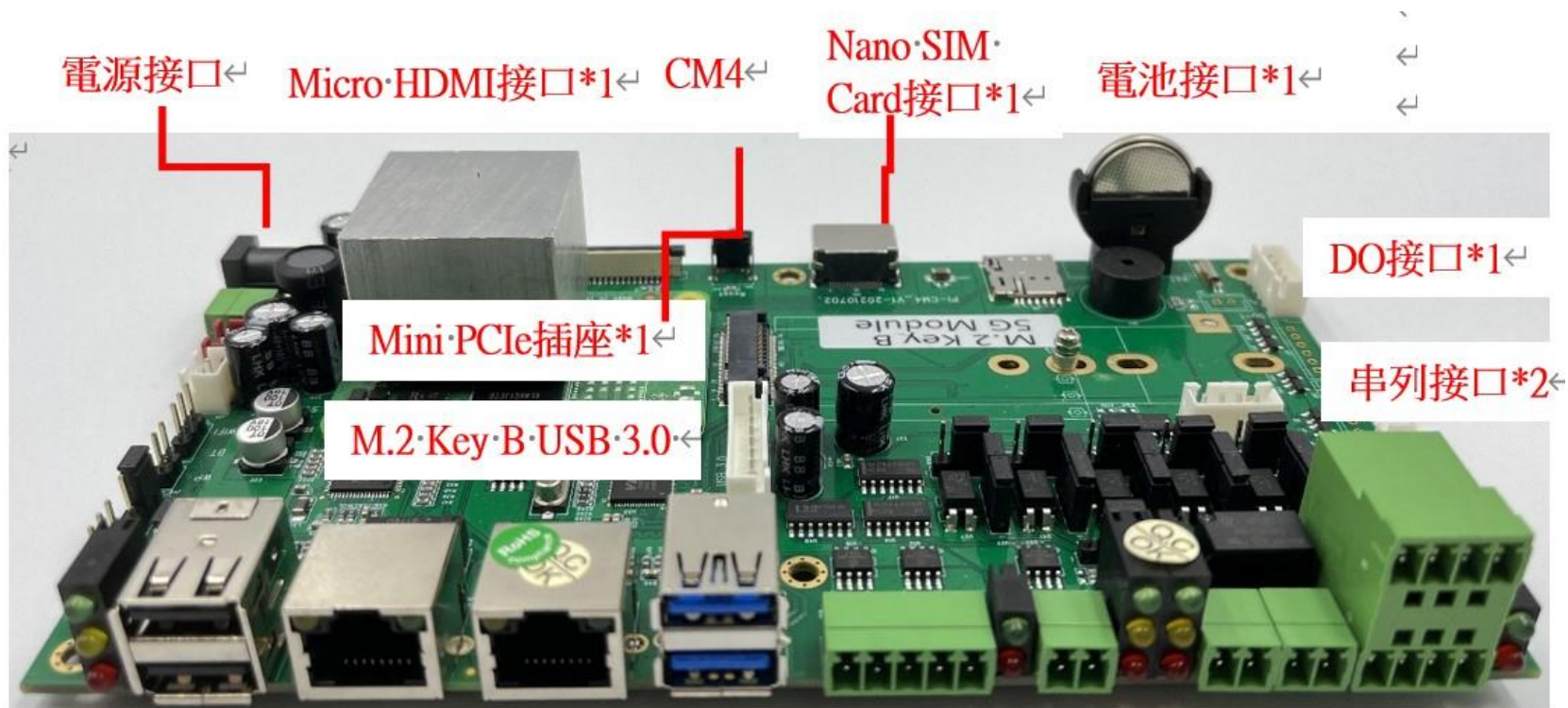

USB·2.0
接口*2

Giga乙太網路RJ45·
*1+10/100M·RJ45*1

USB·2.0
接口*2

串列接口*2

DI接口*5
DO接口*1



Sky LoRa S76-P01 mini PCIe

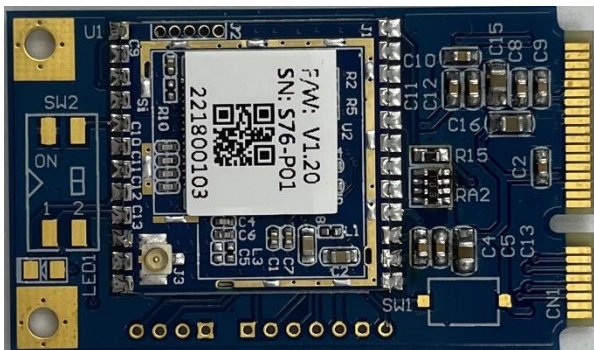

Mini PCIe size

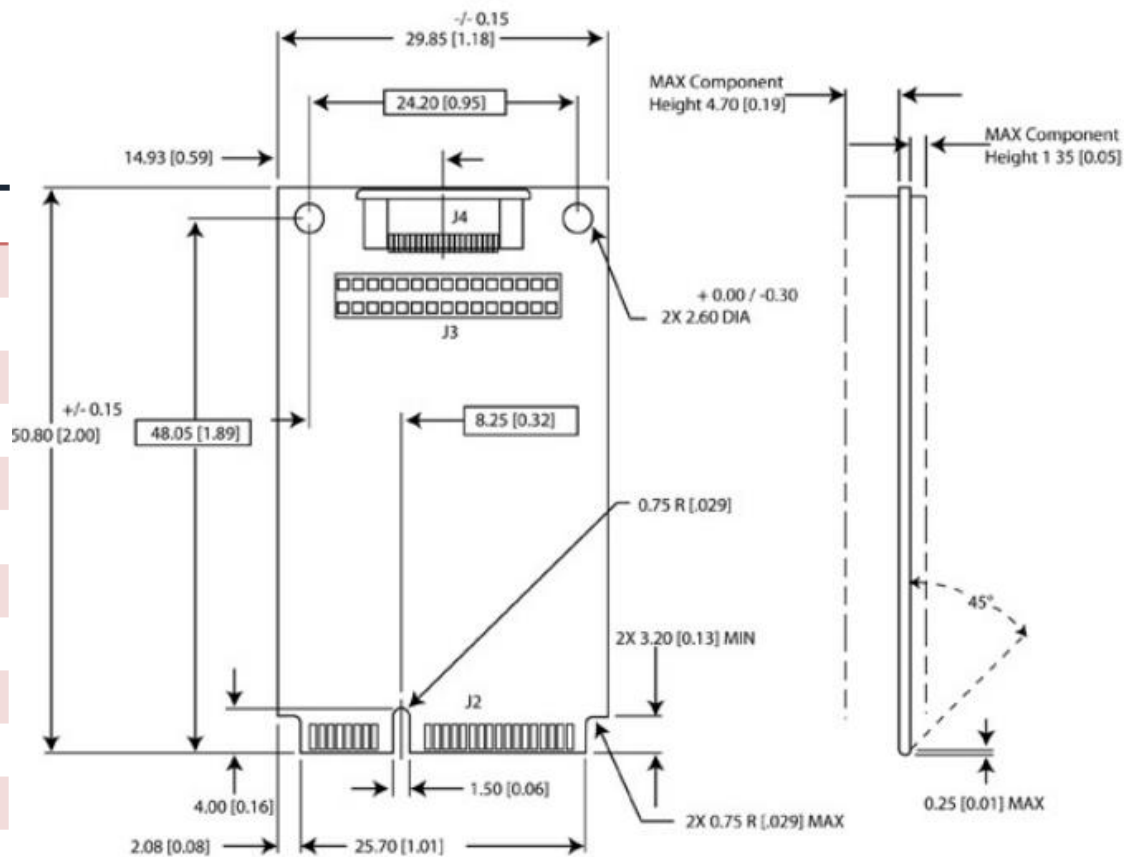

Transceiver	SX1276
MCU	AcSiP STM32L073xZ
Operating supply voltage	3.3V
Frequency	EU868/US915 MHz
Band Width	62.5~500KHz
Modulation	LoRa/GFSK/FSK/OOK/MSK/GMSK
Transmit power	+20dBm max.
Sensitivity	Down to -137dBm
Data rate	300Kbps(FSK)
Communication distance	10Km
Antenna impedance	50Ω
Operating temperature	-40°C ~ +85°C
Storage temperature range	-50°C ~ +105°C
Dimension	50.80mm×29.85mm×6.30mm

IPEX Connector

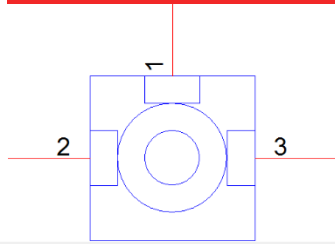

PIN	Definition
1	RF_IN
2	GND
3	GND

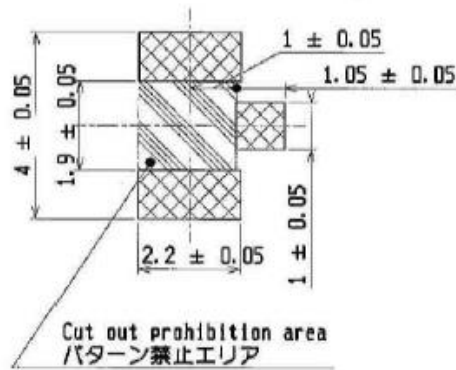
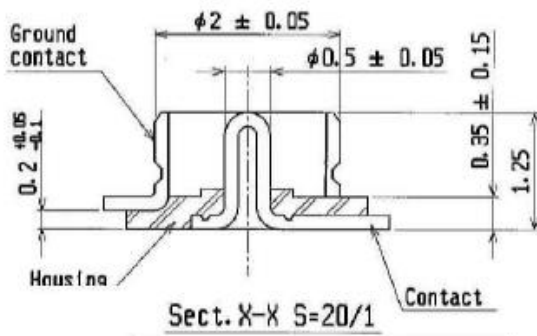
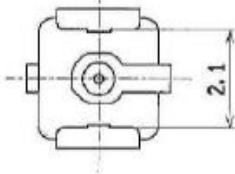
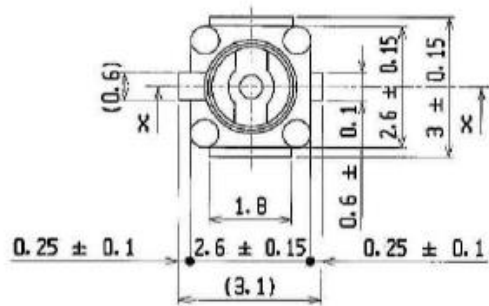

RECOMMENDED FOOTPRINT PATTERN

Pinout

PIN#	PIN NAME	PIN#	PIN NAME
1	N/A	27	N/A
2	3.3V	28	N/A
3	N/A	29	N/A
4	GND	30	N/A
5	N/A	31	N/A
6	N/A	32	N/A
7	N/A	33	N/A
8	N/A	34	GND
9	GND	35	GND
10	N/A	36	SUBD-
11	UART_RX(選)	37	GND
12	N/A	38	SUBD+
13	ART_RX(選)	39	3.3V
14	N/A	40	N/A
15	GND	41	3.3V
16	N/A	42	N/A
17	N/A	43	GND
18	GND	44	N/A
19	N/A	45	N/A
20	Cfg	46	N/A
21	GND	47	N/A
22	RESET(選)	48	N/A
23	N/A	49	N/A
24	3.3V	50	GND
25	N/A	51	N/A
26	GND	52	3.3V

Sky LoRa S76-P01



PIN Definition

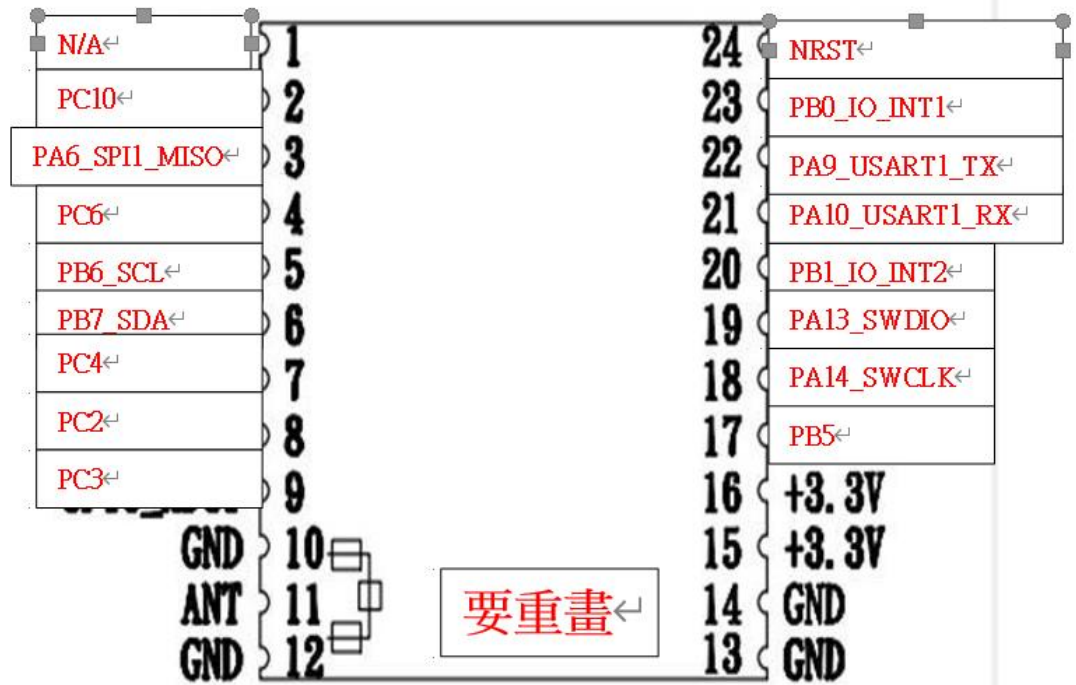

Transceiver	SX1276
MCU	AcSiP STM32L073xZ
Operating supply voltage	3.3V
Frequency	EU868/US915 MHz
Band Width	62.5~500KHz
Modulation	LoRa/GFSK/FSK/OOK/MSK/GMSK
Transmit power	+20dBm max.
Sensitivity	Down to -137dBm
Data rate	300Kbps(FSK)
Communication distance	10Km
Antenna impedance	50Ω
Operating temperature	-40°C ~ +85°C
Storage temperature range	-50°C ~ +105°C
Dimension	23.5mm×23.2mm×3.1mm

Note

- The module transmission data rate will affect Transmission distance, the higher the data rate, the closer the distance, and the lower the receiving sensitivity.
- The supply voltage to the module will affect TX power, in the operating supply voltage range, the lower the voltage to get the lower the TX power.
- The antenna will strongly affect the communication distance, please select matched antenna and connect it correctly.
- The module mount will affect the communication distance.

Pin Configuration

PIN#	PIN NAME	Function Description
1	N/A	N/A
2	PC10	For RS485/1:RS485 Tx, 0: RS485 Rx
3	PA6_SPI1_MISO	GPIO
4	DO1	ModBus-1, DO
5	PB6_SCL	Channel Scan
6	PB7_SDA	Channel Scan
7	PC4	GPIO
8	PC2	GPIO
9	PC3	Cfg Mode(0)/Normal Mode(1) Sel
10	GND	GND
11	ANT	ANT
12	GND	GND
13	GND	GND
14	GND	GND
15	+3.3V	+3.3V
16	+3.3V	+3.3V
17	DO2	GPIO
18	PA14_SWCLK	S/W GPIO - P01, ModBus-2, DO
19	PA13_SWDIO	S/W GPIO - P03, ModBus-2, DI
20	DI2	GPIO
21	PA10_USART1_RX	Pass Through UART RX
22	PA9_USART1_TX	Pass Through UART TX
23	DI1	ModBus-1, DI
24	NRST	Reset

PCB Dimension

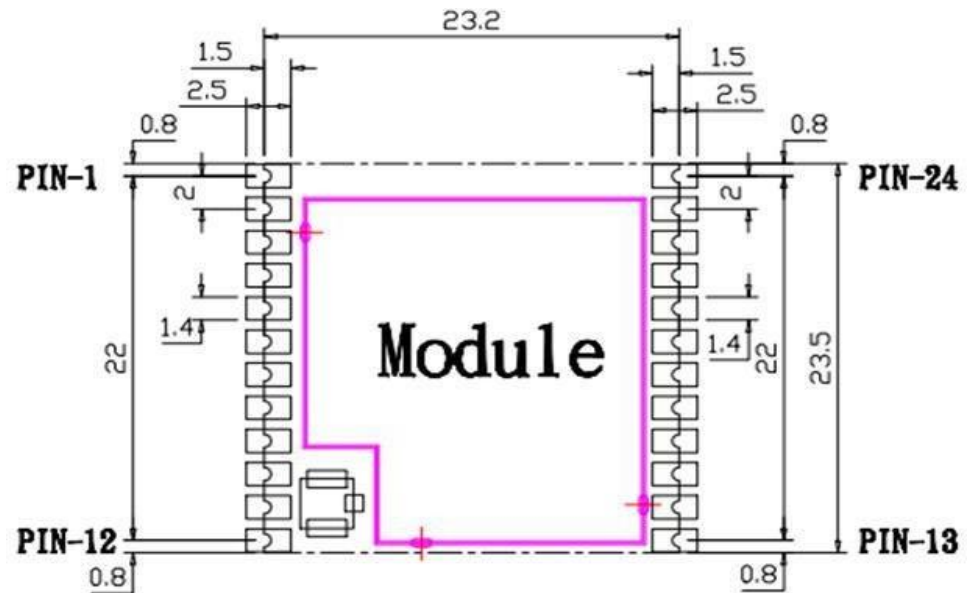

Note

- The module power supply voltage is recommended work at DC3.3V.
- The module interface uses half circle pad to soldering on the system PCB board, the GND must soldering to the system digital GND reliably, or use connector to connect main-board.
- The antenna must get to the module' s ANT pin as close as possible.

LoRa LTE 5G 天線及配件





謝謝聆聽



碩久科技有限公司
MaxLong Technology Co., Ltd